



Product Catalogue 2018





Symbols

Contents

	EHS (Ergonomic Handling System) System adopted for the controls of several power tools, to ensure easy use, reduced fatigue, and the utmost simplification for users.
	Gasoline Gasoline fuel type engine.
	Diesel Diesel fuel type engine.
	Original accessories and spare parts Quality mark identifying original Emak parts and accessories. Designed to the most stringent quality standards, these items guarantee smoother operation of the machine and longer service life.

	Corporate setup	4
	Rotary tillers	10
	Two wheel tractors	20
	Flail mowers	54
	Cutterbar mowers	60
	Transporters	90

Product range

A thorough-going process of product development implemented by Bertolini has resulted in a **truly comprehensive, constantly updated range of machines, suitable for agriculture ground care and maintenance of allotments and gardens** and capable of responding to the needs of users at every level. Products differ according to the use for which they are designed, but all feature the same high standards of quality in terms of performance, reliability, comfort and safety.



Home-plus

A range of machines aimed at the home user, for tidying and cleaning the garden, cutting hedges and small trunks or stems, and DIY jobs in general. Characterized by lightweight and compact construction, to make the task of the operator that much simpler. Easy to start, easy to use, easy to maintain: these are the ideal tools for getting things done quickly and neatly around the home.



Tough-tech

Solid and dependable, these are machines designed for heavy and frequent use in countryside environments: clearing overgrown and uncultivated areas, pruning and cutting firewood, crop irrigation and disinfestation tasks. Designed adopting solutions certain to ensure high work rates and maximum durability over time.



Sharp-pro

No-nonsense everyday tools for the busy professional, these are machines that stand out for the toughness of their components, their high performance and their matchless long-term durability. Specific materials used in construction guarantee unwavering quality even when tackling the most severe and lengthy of tasks, like forestry work and the clearance of uncultivated areas or scrub and undergrowth.

Our Vision

"Innovative solutions for the best customer value"

We aim to operate as one of the world's foremost players in the development, production and distribution of machines, components and accessories for gardening, agriculture, forestry and industry, with an offering of innovative products and services designed to make the work of our clients in the consumer and professional markets efficient and enjoyable, guaranteeing that they always receive the highest possible value.



Structure

The **Emak Group** is active in the development, production and worldwide sale of an extensive range of products for three business segments:

Outdoor Power Equipment

- products for gardening, forestry and agriculture, including brushcutters, lawnmowers, garden tractors, chainsaws, rotary tillers and rotary cultivators.

Pumps and High Pressure Water Jetting

- products for agriculture, including centrifugal and diaphragm pumps for crop spraying and weed control;
- products for industry, including pumps for industrial applications and high and very-high pressure systems;
- products for cleaning, namely professional and semiprofessional high-pressure washers, floor scrubber-dryers and vacuum sweepers.

Components and Accessories

- products such as trimmer line and line heads for brushcutters, accessories for chainsaws, guns, valves and nozzles for high-pressure washers and for agricultural applications, plus precision farming products (sensors and computers).

The group has around **2,000 employees** overall and generates annual sales of approximately **EUR 400 million**.



The Emak Group

Divisions and Product Range

Outdoor Power Equipment

Product range



Pumps and High Pressure Water Jetting

Product range



Components and Accessories

Product range

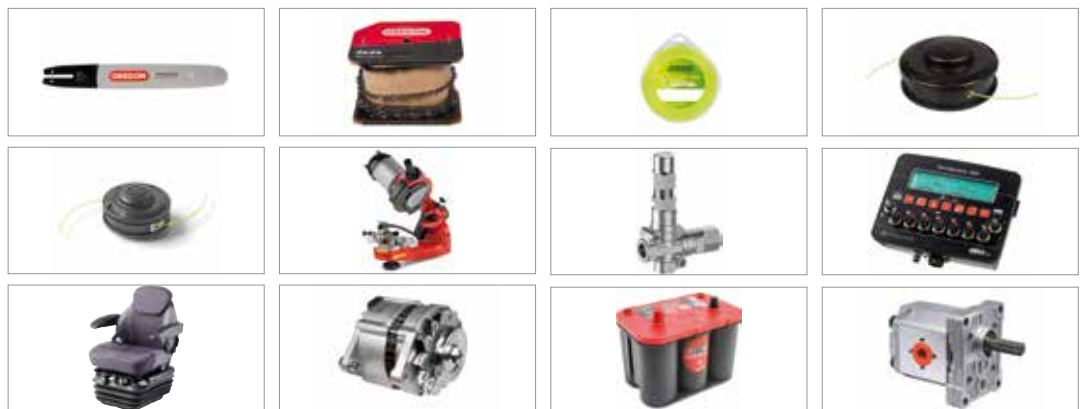

Our Passion

Emak's green ethos is made up of **certainty, innovation** and **completeness**. Our green credentials are based on **care, respect, passion** and **design focus**. That's why, with our **Efco, Oleo-Mac, Bertolini** and **Nibbi** brands, **Emak** stands as a benchmark in groundcare and garden maintenance for professionals and amateurs alike. A **passion** that has been **all-Italian** for more than 50 years. There's an **Emak** for everyone.



Structure

Emak operates in the **Outdoor Power Equipment** segment through **10** companies engaged in the development, production and sale of **products for gardening and forestry, and small agricultural machines**, including brushcutters, lawnmowers, garden tractors, chainsaws, rotary tillers and rotary cultivators.

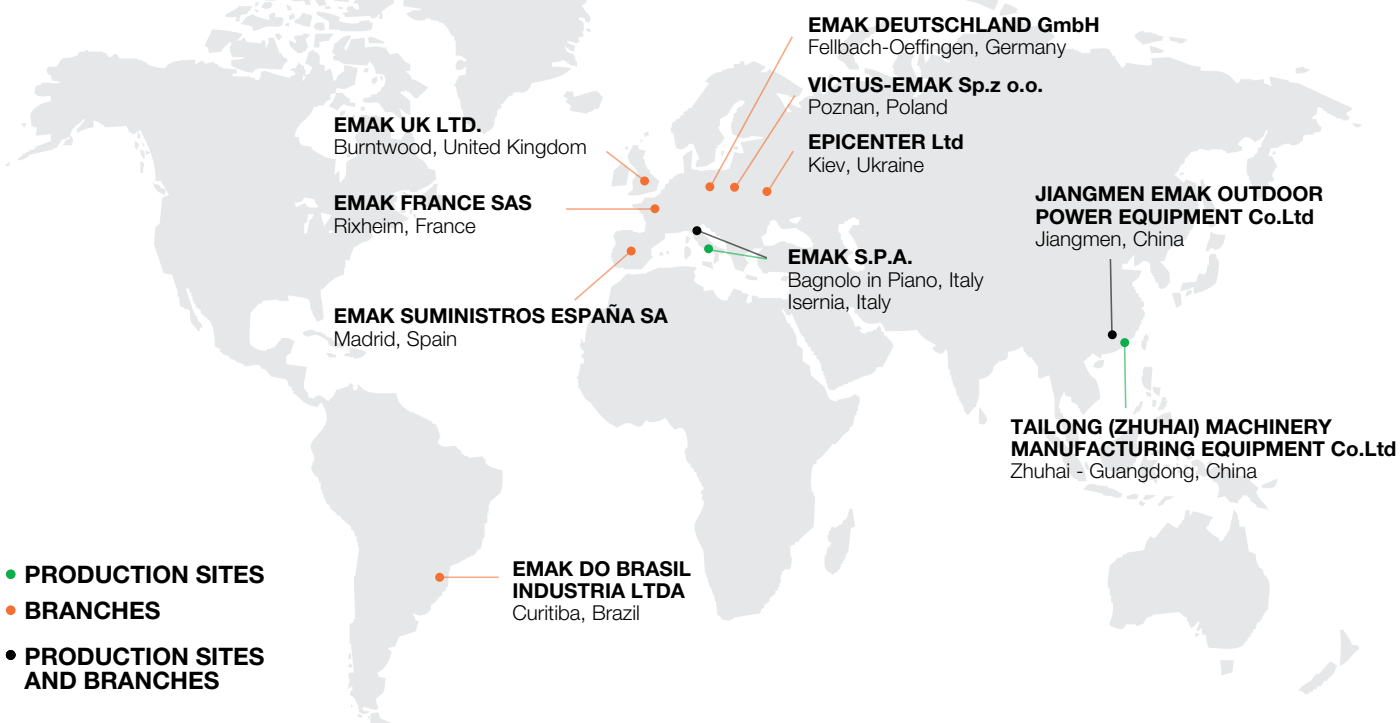

Facts and Figures

4	brands
4	production units
8	foreign sales branches
800	employees (approx.) in 2016
177	million € sales in 2016
135	distributors
85	countries served
22.000	points of sale supplied
20	product families
200	models



Outdoor Power Equipment

Certifications

Yes, we care.

We were the world's first company in our field to obtain certifications in three crucial areas of business sustainability:

- Ethics
- Environment
- Quality

We care

Certified Quality Ethics Environment

Products and Accessories Range

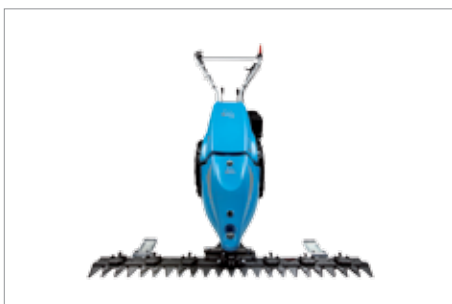

Gardening, farming and forestry tools for home users and professionals. **Bertolini** covers all shades of green. With different models to meet each user's needs but all sharing the same exceptional quality standards in terms of performance, reliability, comfort and safety.

The accessories range is offered as an extension and completion of the product range. Ergonomics, quality and styling are essential ingredients of the development of **Bertolini's** products: primarily designed to meet the needs of professionals whilst also taking care of the requirements of less expert users who insist on the very best. A truly comprehensive range of superb quality products at highly competitive prices – that's the **Bertolini** formula.





Rotary tillers

Rotary tiller for intensive use
205

16

Cutterbar mowers

Cutterbar mower for intensive use
130 S

68



Specialist machines for soil preparation.
Powerful and sturdy over large areas,
practical and reliable even in private gardens
and allotments: a wide range
to suit all needs.



Rotary tillers

HOME



020



195



INTENSIVE



205

NEW



PROFESSIONAL



215



TECHNICAL DATA



gearbox



power



rotor

Rotary tiller for home use

020



Ideal for private users with small plots and gardens requiring periodic maintenance. Also designed for a variety of jobs such as preparing soil for grass seeding, digging furrows for planting, and other operations such as turf scarification and path tidying.



Folding handlebars for easy storage and transport (e.g. in the boot of a car).



Spur gear and worm gear drive protected by robust aluminium housing for maximum resistance to impact (stones, low walls, fences) and operating stresses.



The front engine guard enables the machine to be rested upright in the garage or tool shed, saving considerable space.

020

Power supply	Engine	Model	Displacement	Power	Starting	Code
gasoline	POWERED by HONDA	GX 25 OHV	25 cm ³	0.8 HP	recoil start	68609130A

Focus on accessories



Roller brush
Code **68602002**

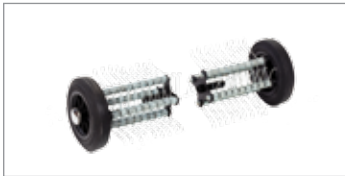

Scarifier
Code **68602003**



Plough
Code **68602004**



Gearbox/ Speed (km/h):

1-speed (1 forward)

Speed (km/h) 1.80

Rotor speed with engine at 3600 rpm 162

Dimensions (mm)

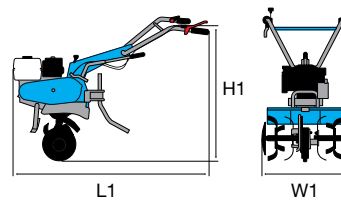

L1	1250
H1	1000
W1	300

Transmission	worm gear drive in aluminium housing
Clutch	centrifugal
Handlebars	reversible
Rotor	30 cm
Power take-off	no
Spur	yes
Towing hitch	no
Transport wheel	yes
Weight	14 kg

Rotary tiller for home use

195



Ideal for home gardeners who need to soften up the soil for seeding, this model offers an excellent combination of manageability and user-friendliness.



Front wheel for easy transportation of the machine. The wheel can be easily folded upward without tools to facilitate operations on the ground.

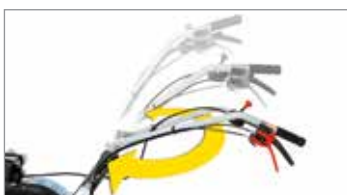

Handlebars with horizontal and vertical adjustment to allow the operator to assume the correct posture while working.







82 cm rotor with three elements per side with lateral protection discs.

195

Power supply	Engine	Model	Displacement	Power	Starting	Code
gasoline	Emak	K 800 HT OHV	182 cm ³	5.7 HP	recoil start	68599001EN

Focus on accessories

	Furrowing tool Code 69209081 (requires tool holder 69209087)
	Plough Code 69209082 (requires tool holder 69209087)
	Potato digger Code 69209083 (requires tool holder 69209087)
	Tool holder Code 69209087
	Pair of metal wheels Code 69209084



Gearbox/ Speed (km/h):

2-speed (1 forward + 1 reverse)

Speed (km/h)	8.40 1 1R 3.50
Rotor speed with engine at 3400 rpm	159 1 1R 66

Dimensions (mm)

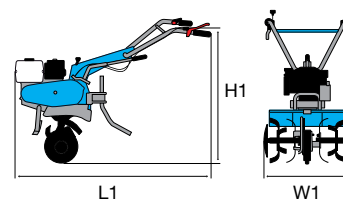

L1	1400
H1	800
W1	820-550

Transmission	chain
Clutch	belt with tensioner
Handlebars	with vertical and horizontal adjustment
Rotor	82 cm, can be reduced to 55 cm, with lateral protection discs
Power take-off	no
Spur	yes
Towing hitch	yes
Transport wheel	yes
Weight	57 kg

Rotary tiller for intensive use

205

NEW



Ideal for demanding home gardeners to prepare the soil for sowing. This model features two forward speeds and one reverse, the perfect combination for the most difficult jobs.



Practical and ergonomic external gear selector.



Handlebars with vertical and horizontal adjustment by means of an easily accessible lever, allowing the operator to assume the correct posture for the maximum working comfort.









85 cm rotor with lateral protection discs.

205

Power supply	Engine	Model	Displacement	Power	Starting	Code
gasoline	Emak	K 800 HC OHV	182 cm ³	5.7 HP	recoil start	68589010EN

Focus on accessories

	Furrowing tool Code 69209081 (requires tool holder 69209088)
	Plough Code 69209082 (requires tool holder 69209088)
	Potato digger Code 69209083 (requires tool holder 69209088)
	Tool holder Code 69209088
	Pair of metal wheels Code 69209116
	Pair of tyred wheels 3.50-6" Code 69209089
	Pair of tyred wheels 3.50-8" Code 69209114



Gearbox/ Speed (km/h):

3-speed (2 forward + 1 reverse)

Speed (km/h)	4.70 1	1R 3.50
	6.50 2	
Rotor speed with engine at 3400 rpm	83 1	1R 62
	114 2	

Dimensions (mm)

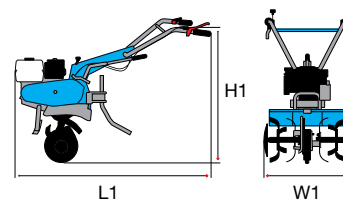

L1	1630
H1	1050
W1	850-600

Transmission	with oil-bath gearbox and chain
Clutch	belt with tensioner
Handlebars	with vertical and horizontal adjustment
Rotor	85 cm, reducible to 60 cm, with side protection discs
Power take-off	no
Spur	yes
Towing hitch	yes
Transport wheel	yes
Weight	63 kg

Professional rotary tiller

215



Extremely reliable model, designed for the professional needs of farmers and groundsmen. Direct gear-driven transmission on drive shaft makes it extremely resistant to stress when working on hard ground.



Direct transmission with gears on the crankshaft for the maximum resistance to stress.



Extreme versatility thanks to the 3-speed gearbox (2 forward + 1 reverse) that makes it possible to achieve the same tillage results irrespective of the hardness and consistency of the soil.



Oil-bath gear drive, robust and very low maintenance.

215

Power supply	Engine	Model	Displacement	Power	Starting	Code
gasoline	POWERED BY HONDA	GX 160 OHV	163 cm ³	4.8 HP	recoil start	68649020DEN
gasoline	Emak	K 800 H OHV	182 cm ³	5.7 HP	recoil start	68649034BEN
diesel	KIPOR	KM 178	296 cm ³	5.5 HP	recoil start	68649045EN **

** Available while stocks last.

Focus on accessories



Pair of lateral transport wheels Ø 420 mm
Code **68600001**



Adjustable furrower
Code **68600006**



Flange for wheels
Code **L0093800**



Pair of tyred wheels 4.00-8"
Fixed disc
Code **69209025B**
(requires wheel flange **L0093800**)



Pair of steel wheels Ø 410x60 mm
Code **L0756011**
(requires wheel flange **L0093800**)



Gearbox/ Speed (km/h):

3-speed (2 forward + 1 reverse)

Speed (km/h)

5.08 **1** **1R** 2.77
8.00 **2**

Rotor speed with engine at 3600 rpm

87 **1** **1R** 48
147 **2**

Dimensions (mm)

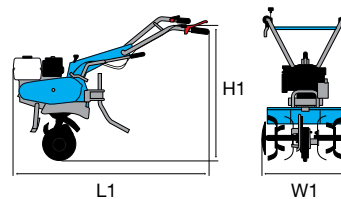

L1	1350
H1	800
W1	870-600

Transmission	with oil-bath gearbox
Clutch	oil-immersed bevel type
Handlebars	with vertical and horizontal adjustment
Rotor	87 cm, reducible to 60 cm, with side protection discs
Power take-off	yes, independent 2100 rpm
Spur	yes
Towing hitch	yes
Transport wheel	yes
Weight	80 kg with petrol engine – 90 kg with diesel engine

Powerful and reliable,
easy to handle, reversible and versatile,
these machines represent
the ideal solution for all ground jobs
in any season.



Two wheel tractors

HOME



400



401 S



INTENSIVE



405 S



407 S



413 S



PROFESSIONAL



417 S



418 S



TECHNICAL DATA



gearbox



brakes



power



differential block



reverse gear



half-shafts with reduction gears

OPTIONAL



rotor



brush



plough



turbine



flail mower



shovel



cutter bar



trailer

Two wheel tractor for home use

400



Ideal for home users with small gardens requiring periodic soil preparation for sowing, also in particularly difficult conditions. The rotor turns in the opposite direction to the direction of rotation of the wheels, thus giving the operator the maximum control of the cultivator and significantly reducing transmitted vibration levels.



50 cm wide counter-rotating rotor to facilitate work on particularly difficult terrain.



Large sized wheels for easier maneuvering of the machine.



Rotor depth adjustment enables operation on all types of terrain.

400

Power supply	Engine	Model	Displacement	Power	Starting	Code
gasoline	Emak	K 700 H OHV	182 cm ³	5.4 HP	recoil start	68369001AEN

Focus on accessories



Rear-mounted furrowing tool
Code **69209111**



Pair of steel wheels Ø 370 mm
Code **L0051200**



WITH TWO WHEEL TRACTOR

Gearbox/ Speed (km/h):

2-speed (1 forward + 1 reverse) with 4.00-8" wheels

Speed (km/h)

1.45 **1** **1R** 2.64

Dimensions (mm)

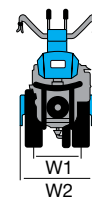
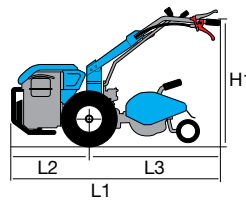

L1	1650
L2	540
L3	1110
H1	960
W1	430
W2	500

Transmission	with oil-bath gearbox
Clutch	direct engagement
Handlebars	with vertical adjustment
Reverse gear	no
Differential	no
Brakes	no
Power take-off	synchronised with forward travel
Accessories installation	no
Towing hitch	no
Cowling	no
Weight	75 kg (complete machine)

Two wheel tractor for home use

401 S



Designed for demanding home gardeners tending an allotment or vegetable plot, this two wheel tractor is extremely functional and offers the optimal combination of ease of use and safety.



Handlebar-mounted PTO control.



Handlebars with vertical and horizontal adjustment and 180° reversible, with vibration-damping device to assure more comfortable handling.



Integral QuickFit coupling that allows the operator to change the tools without using tools.

401 S

Power supply	Engine	Model	Displacement	Power	Starting	Code
gasoline	POWERED BY HONDA	GX 160 OHV	163 cm ³	4.8 HP	recoil start	68319100AEN
gasoline	Emak	K 800 H OHV	182 cm ³	5.7 HP	recoil start	68319102AEN

Accessories







401 S

Accessory		Optional accessory		
Rotors				
 <p>Rotor Ø 280, 50-(35) cm 12 spikes coupling for Quickfit (can be reduced to 35 cm with kit L0116300)</p>	69219110		Support wheel	Z0020368
			Rear-mounted furrowing tool	L0050600
 <p>Rotor Ø 280, 60-50-(35) cm 16 spikes coupling for Quickfit (can be reduced to 35 cm with kit L0116300)</p>	69219107		Support wheel	Z0020368
			Rear-mounted furrowing tool	L0050600
Tyred wheels				
 <p>Pair of tyred wheels 4.00x8" Fixed disc Quickfit coupling</p>	69209020A		Pair of snow chains	L1055015
			Pair of spacers L 100 mm	69209096
Steel wheels				
 <p>Pair of steel wheels Ø 370 mm</p>	L0051200			



Accessories

Accessory		Optional accessory			
Towing hitch					
	Towing hitch	L0060900			
Adjustable tool holder					
	Adjustable tool holder (requires towing hitch L0060900)	L0103400		Single share plough	L0100000
				Furrowing tool	L0103200
Bar drive					
	Cam drive	69229091		0.92 m Complete central cutter plate Special teeth	69222011
Front brush					
	Brush L 80-Ø 35 cm With horizontal and vertical adjustment	L0070000			

Two wheel tractor for intensive use

405 S



Designed for small and medium-size plots, this machine very effectively combines professional level reliability and performance with extreme ease of handling, making it ideal for demanding home users and smallholders. The full range of accessories, including rotors, cutterbars, brushes and snowthrowers, are designed to meet the requirements of users seeking a multifunction machine that's both practical and safe.



Handlebars with vertical and horizontal adjustment and 180° reversible, with vibration-damping device to assure more comfortable handling.



The EHS system ensures ease of use, reduced effort and the maximum simplification for users.



Practical forward/reverse shuttle enables the operator to change quickly into reverse gear from any speed, making the machine easy to handle even with the rotor or other accessories mounted.

405 S

Power supply	Engine	Model	Displacement	Power	Starting	Code
gasoline	POWERED BY HONDA	GX 200 OHV	196 cm ³	5.8 HP	recoil start	68359007EN
gasoline	Emak	K 800 H OHV	182 cm ³	5.7 HP	recoil start	68359004EN

Focus on accessories



Rotor Ø 280, 60-50-(40) cm
16 spikes
Fixed coupling
(can be reduced to 40 cm
with kit **69210259**)
Code **69219103**



Oil-immersed drive
Code **69229096**



Front shovel L 100x40 cm
Quickfit coupling
With horizontal and vertical
adjustment
(requires QuickFit **69212006**)
Code **69209065**



WITH TWO WHEEL TRACTOR

Gearbox/ Speed (km/h):

4-speed (2 forward + 2 reverse) with 4.00-8" wheels

Speed (km/h)	1.05	1	1R	1.11
	2.20	2	2R	2.32

Dimensions (mm)

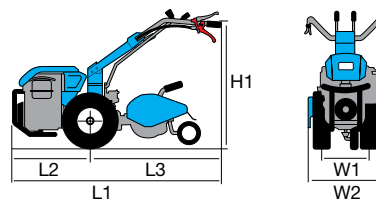

L1	1740
L2	550
L3	1190
H1	1250-300
W1	370
W2	600-400

WITH CUTTERBAR MOWER

Gearbox/ Speed (km/h):

4-speed (2 forward + 2 reverse) with 4.00-8" wheels

Speed (km/h)	1.11	1	1R	1.05
	2.32	2	2R	2.20

Dimensions (mm)

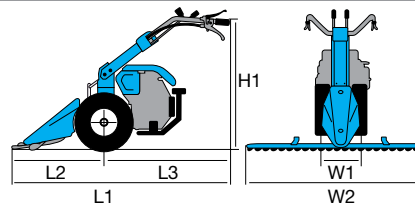



















L1	1670
L2	900
L3	770
H1	1250-300
W1	370
W2	1270-950

Transmission	with oil-bath gearbox
Clutch	dry bevel type
Handlebars	with vertical and horizontal adjustment and 180° reversible, with vibration-damping device
Reverse gear	yes, with handlebar lever
Differential	no
Brakes	no
Power take-off	independent 973 rpm
Accessories installation	QuickFit (optional)
Towing hitch	optional
Cowling	no
Weight	90 kg (with engine, rotor and wheels)

Accessories



















405 S

Accessory		Optional accessory			
Rotors					
	Rotor Ø 280, 60-50-(40) cm 16 spikes Fixed coupling (can be reduced to 40 cm with kit 69210259)	69219103		Support wheel	Z0020368
				Rear-mounted furrowing tool	L0009800
	Rotor Ø 280, 60-50-(40) cm 16 spikes Quickfit included (can be reduced to 40 cm with kit 69210259)	69219089		Support wheel	Z0020368
				Rear-mounted furrowing tool	L0009800
Tyred wheels					
	Pair of tyred wheels 4.00x8" Fixed disc Quickfit coupling	69209110		Pair of snow chains	L1055015
	Pair of tyred wheels 4.00x10" Fixed disc (requires spacers 69209112)	69200024A		Pair of snow chains	L0021600
Steel wheels					
	Pair of steel wheels Ø 480x100 mm (requires spacers 69209112)	69209067		Pair of width adjustment rings W 100 mm	L0040100
Towing hitch					
	Towing hitch	69209072			
Adjustable tool holder					
	Adjustable tool holder (requires towing hitch 69209072)	L1055001A		Single share plough	Z0020102
				Furrowing tool	Z0020133
				Potato digger	L0066400
QuickFit					
	QuickFit coupling	69212006			



Accessories

Accessory		Optional accessory		
Drives and Cutter plates				
 <p>Oil-immersed drive</p>	69229096		0.95 m Complete central cutter plate Semi-fine teeth	69229084A
			1.15 m Complete central cutter plate Semi-fine teeth	69229085A
			1.27 m Complete central cutter plate Semi-fine teeth	69229086A
			0.95 m Complete central cutter plate Special teeth Side protection discs	69229068A
			1.15 m Complete central cutter plate Special teeth Side protection discs	69229069A
			1.27 m Complete central cutter plate Special teeth Side protection discs	69229070A
			1.22 m Complete central cutter plate " UNIVERSAL " ESM (requires kit L0058900)	69229036
			1.02 m Complete central cutter plate " KOMUNAL " ESM (requires kit L0058900)	L0066900
			1.22 m Complete central cutter plate " KOMUNAL " ESM (requires kit L0058900)	69229037
			Ballast for oil-immersed drive	L0105700
	Directional guides for semi-fine tooth cutter plate	69229098		
Front shovel				
	<p>Front shovel L 100x40 cm Quickfit coupling With horizontal and vertical adjustment (requires QuickFit 69212006)</p>	69209065		
Snow thrower				
	<p>Turbine L 60 cm Two stages Adjustable ejector chute Quickfit coupling (requires QuickFit 69212006)</p>	L0026200		
Front brush				
	<p>Brush L 100xØ 35 cm With horizontal and vertical adjustment Quickfit coupling (requires QuickFit 69212006)</p>	L0094200		
Rotor type flail mower				
	<p>Flail mower L 65 cm 24 'Y' shaped knives Integral safety brake Quickfit coupling (requires QuickFit 69212006)</p>	L0091000		

Two wheel tractor for intensive use

407 S



Thanks to the differential with locking lever on the handlebars, which affords perfect manoeuvrability and grip even on the most difficult terrain and on slopes, the key strength of this machine is its ease of use. The facility to use a range of different accessories for tillage, grass cutting and maintenance of gardens or urban spaces makes these machines exceptionally versatile and perfectly adapted to meet the needs of demanding home users and smallholders.



Ergonomically positioned easy action levers for differential locking and reverse shuttle.



Independent brakes on each wheel and handlebar steering to facilitate travel on even the most difficult terrain.



QuickFit coupling that allows the operator to change the tools without using tools.

407 S

Power supply	Engine	Model	Displacement	Power	Starting	Code
gasoline	POWERED BY HONDA	GX 200 OHV	196 cm ³	5.8 HP	recoil start	68359100EN
gasoline	Emak	K 800 H OHV	182 cm ³	5.7 HP	recoil start	68359101EN
gasoline	KOHLER	CH 270 OHV	208 cm ³	7.0 HP	recoil start	68359104EN
diesel	KIPOR	KM 178	296 cm ³	5.5 HP	recoil start	68359105EN **
diesel	Emak	K 7000 HD	349 cm ³	6.7 HP	recoil start	68359114EN

** Available while stocks last.

Focus on accessories



Rotor Ø 280, 60-50-(40) cm
16 spikes
Quickfit included
(can be reduced to 40 cm with kit **69210259**)
Code **69219089**



Turbine L 60 cm
Two stages
Adjustable ejector chute
Quickfit coupling
(requires QuickFit **69212006**)
Code **L0026200**



Flail mower L 65 cm
24 'Y' shaped knives
Integral safety brake
Quickfit coupling
(requires QuickFit **69212006**)
Code **L0091000**



WITH TWO WHEEL TRACTOR

Gearbox/ Speed (km/h):

4-speed (2 forward + 2 reverse) with 4.00-10" wheels

Speed (km/h)	1.20	1	1R	1.27
	2.52	2	2R	2.66

Dimensions (mm)

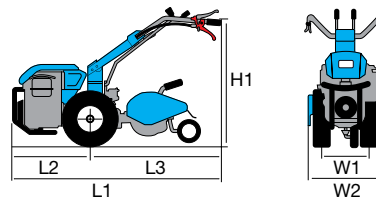

L1	1780
L2	570
L3	1210
H1	1340-470
W1	370
W2	700-400

WITH CUTTERBAR MOWER

Gearbox/ Speed (km/h):

4-speed (2 forward + 2 reverse) with 4.00-10" wheels

Speed (km/h)	1.27	1	1R	1.20
	2.66	2	2R	2.52

Dimensions (mm)

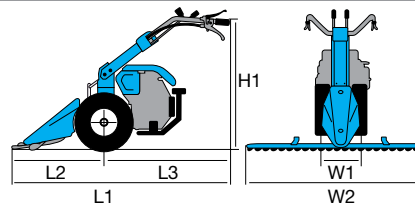









L1	1690
L2	900
L3	790
H1	1440-620
W1	370
W2	1420-950

Transmission	with oil-bath gearbox
Clutch	dry bevel type
Handlebars	with vertical and horizontal adjustment and 180° reversible, with vibration-damping device
Reverse gear	yes, with handlebar lever
Differential	yes
Brakes	yes
Power take-off	independent 973 rpm
Accessories installation	QuickFit (optional)
Towing hitch	yes
Cowling	no
Weight	120 kg (with engine, rotor and wheels)

Accessories



407 S

Accessory	Optional accessory		
 <p>Rotor Ø 280, 60-50-(40) cm 16 spikes Fixed coupling (can be reduced to 40 cm with kit 69210259)</p>	69219103	 <p>Support wheel</p>	Z0020368
 <p>Rotor Ø 280, 60-50-(40) cm 16 spikes Quickfit included (can be reduced to 40 cm with kit 69210259)</p>		69219089	 <p>Rear-mounted furrowing tool</p>
 <p>Rotor Ø 320, (80)-70-60-(50) cm 20 spikes Quickfit included Support wheel included (expandable to 80 cm with kit 69210231) (can be reduced to 50 cm with kit 69210229)</p>	69219060		 <p>Support wheel</p>
 <p>Rotor Ø 320, (80)-70-60-(50) cm 20 spikes Fixed coupling Support wheel included (expandable to 80 cm with kit 69210231) (can be reduced to 50 cm with kit 69210229)</p>		69219066	 <p>Rear-mounted furrowing tool</p>
			 <p>Rear-mounted furrowing tool</p>







Accessories

Accessory		Optional accessory		
Tyred wheels				
 <p>Pair of tyred wheels 4.00x8" Fixed disc</p>	69209025B	 <p>Screw-adjustable half-shafts</p>	69209105	
		 <p>5-hole adjustable half-shafts</p>	L0059500	
		 <p>Pair of spacers L 50 mm</p>	69209094	
		 <p>Pair of snow chains</p>	L1055015	
 <p>Pair of tyred wheels 4.00x10" Fixed disc</p>	69200024A	 <p>Screw-adjustable half-shafts</p>	69209105	
		 <p>5-hole adjustable half-shafts</p>	L0059500	
		 <p>Pair of spacers L 50 mm</p>	69209094	
		 <p>Pair of snow chains</p>	L0021600	
 <p>Pair of tyred wheels 4.00x10" Adjustable disc</p>	69209004B	 <p>Pair of 15 kg ballasts (not compatible with adjustable half-shafts)</p>	69209099	
		 <p>Pair of 15 kg ballasts (compatible with adjustable half-shafts)</p>	69209075	
		 <p>Screw-adjustable half-shafts</p>	69209105	
		 <p>5-hole adjustable half-shafts</p>	L0059500	
		 <p>Pair of spacers L 50 mm</p>	69209094	
		 <p>Pair of snow chains</p>	L0021600	
 <p>Pair of tyred wheels 5.00x10" Adjustable disc</p>	69209003B	 <p>Pair of 15 kg ballasts (not compatible with adjustable half-shafts)</p>	69209099	
		 <p>Pair of 15 kg ballasts (compatible with adjustable half-shafts)</p>	69209075	
		 <p>Screw-adjustable half-shafts</p>	69209105	
		 <p>5-hole adjustable half-shafts</p>	L0059500	
		 <p>Pair of spacers L 50 mm</p>	69209094	
		 <p>Pair of snow chains</p>	L0030200	
 <p>Pair of tyred wheels 16-6.50x8" Fixed disc</p>	69209012A	 <p>Screw-adjustable half-shafts</p>	69209105	
		 <p>5-hole adjustable half-shafts</p>	L0059500	

Accessories



407 S

Accessory		Optional accessory		
Steel wheels				
 Pair of steel wheels Ø 480x100 mm	69209067	 Pair of width adjustment rings W 100 mm	L0040100	
		 Screw-adjustable half-shafts	69209105	
		 5-hole adjustable half-shafts	L0059500	
		 Pair of spacers L 50 mm	69209094	
Adjustable tool holder				
 Adjustable tool holder	L1055001A	 Single share plough	Z0020102	
		 Furrowing tool	Z0020133	
		 Potato digger	L0066400	
Drives and Cutter plates				
 Oil-immersed drive	69229096	 0.95 m Complete central cutter plate Semi-fine teeth	69229084A	
		 1.15 m Complete central cutter plate Semi-fine teeth	69229085A	
		 1.27 m Complete central cutter plate Semi-fine teeth	69229086A	
		 1.40 m Complete central cutter plate Semi-fine teeth	69229087A	
		 0.95 m Complete central cutter plate Special teeth Side protection discs	69229068A	
		 1.15 m Complete central cutter plate Special teeth Side protection discs	69229069A	
		 1.27 m Complete central cutter plate Special teeth Side protection discs	69229070A	
		 1.40 m Complete central cutter plate Special teeth Side protection discs	69229071A	
		 1.22 m Complete central cutter plate "UNIVERSAL" ESM (requires kit L0058900)	69229036	
		 1.42 m Complete central cutter plate "UNIVERSAL" ESM (requires kit L0058900)	69229021	
		 1.02 m Complete central cutter plate "KOMUNAL" ESM (requires kit L0058900)	L0066900	
		 1.22 m Complete central cutter plate "KOMUNAL" ESM (requires kit L0058900)	69229037	
		 1.42 m Complete central cutter plate "KOMUNAL" ESM (requires kit L0058900)	69229038	
		 Ballast for oil-immersed drive	L0105700	
 Directional guides for semi-fine tooth cutter plate	69229098			



Accessories

Accessory		Optional accessory		
Front shovel				
	<p>Front shovel L 100x40 cm Quickfit coupling With horizontal and vertical adjustment (requires QuickFit 69212006)</p>	69209065		
Snow thrower				
	<p>Turbine L 60 cm Two stages Adjustable ejector chute Quickfit coupling (requires QuickFit 69212006)</p>	L0026200		
Front brush				
	<p>Brush L 100xØ 35 cm With horizontal and vertical adjustment Quickfit coupling (requires QuickFit 69212006)</p>	L0094200		
Rotor type flail mower				
	<p>Flail mower L 65 cm 24 'Y' shaped knives Integral safety brake Quickfit coupling (requires QuickFit 69212006)</p>	L0091000		
Trailer				
	<p>Towed trailer with handlebar steering Load box dimensions 1.25x0.95 m Load box depth 30 cm Wheels 145x70-8" Max load capacity 300 kg Pedal operated brake Parking handbrake Dump box Collapsible tailgate (not homologated for road use)</p>	L0018601		
QuickFit				
	QuickFit coupling	69212006		

Two wheel tractor for intensive use

413 S



Designed for professional users, with a 3-speed gearbox and differential, this machine, in its various different engine versions, is designed to take the most punishing conditions in its stride. Very versatile and safe, with its EHS system for easy clutch control this machine combines ruggedness and exceptional ease of handling. Individual user requirements can be met with the generous range of accessories available.



Ergonomically positioned easy action levers for differential locking and reverse shuttle.



The EHS system ensures ease of use, reduced effort and the maximum simplification for users.



QuickFit coupling that allows the operator to change the tools without using tools.

413 S

Power supply	Engine	Model	Displacement	Power	Starting	Notes	Code
gasoline	POWERED by HONDA	GX 270 OHV	270 cm ³	8.4 HP	recoil start		68329201EN
gasoline	POWERED by HONDA	GX 340 OHV	389 cm ³	10.7 HP	recoil start		68329200EN
gasoline	KOHLER	CH 395 OHV	277 cm ³	9.5 HP	recoil start		68329206EN
diesel	LOMBARDINI A KOHLER COMPANY	15LD350	349 cm ³	7.5 HP	recoil start		68329226EN
diesel	KIPOR	KM 186	406 cm ³	8.5 HP	recoil start		68329207EN **
diesel	KIPOR	KM 186	406 cm ³	8.5 HP	recoil start/ electric	battery supplied as standard	68329208EN **
diesel	Emak	K 9000 HD	441 cm ³	9.2 HP	recoil start/ electric	battery supplied as standard	68329235EN
diesel	LOMBARDINI A KOHLER COMPANY	15LD440	441 cm ³	10.9 HP	recoil start		68329205EN
diesel	LOMBARDINI A KOHLER COMPANY	15LD440	441 cm ³	10.9 HP	recoil start/ electric	battery supplied as standard	68329202EN

** Available while stocks last.

Focus on accessories



Rotor Ø 320, (80)-70-60-(50) cm
 20 spikes
Quickfit included
 Support wheel included
 (expandable to 80 cm with kit **69210231**)
 (can be reduced to 50 cm with kit **69210229**)
 Code **69219060**



Turbine L 60 cm
Two stages
 Adjustable ejector chute
Quickfit coupling
 (requires QuickFit **69212006**)
 Code **L0026200**



Flail mower L 65 cm
 24 'Y' shaped knives
 Integral safety brake
Quickfit coupling
 (requires QuickFit **69212006**)
 Code **L0091000**



WITH TWO WHEEL TRACTOR

Gearbox/ Speed (km/h):

6-speed (3 forward + 3 reverse) with 5.00-10" wheels

Speed (km/h)	1.26	1	1R	1.33
	2.64	2	2R	2.79
	4.37	3	3R	4.62

Dimensions (mm)

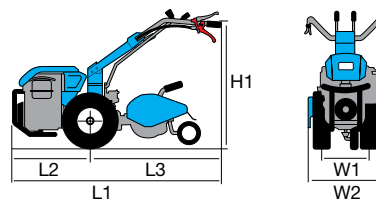

L1	1800
L2	690
L3	1110
H1	1470-630
W1	370
W2	800-400

WITH CUTTERBAR MOWER

Gearbox/ Speed (km/h):

6-speed (3 forward + 3 reverse) with 5.00-10" wheels

Speed (km/h)	1.33	1	1R	1.26
	2.79	2	2R	2.64
	4.62	3	3R	4.37

Dimensions (mm)

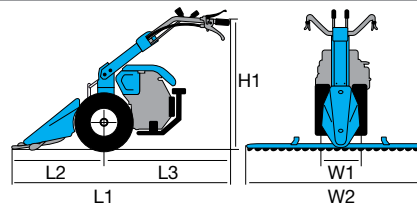









L1	1770
L2	900
L3	870
H1	1440-570
W1	370
W2	1420-950

Transmission	with oil-bath gearbox
Clutch	dry multidisc
Handlebars	with vertical and horizontal adjustment and 180° reversible, with vibration-damping device
Reverse gear	yes, with handlebar lever
Differential	yes
Brakes	yes
Power take-off	independent 973 rpm
Accessories installation	QuickFit (optional)
Towing hitch	yes
Cowling	yes
Weight	130 kg (with diesel engine, rotor and wheels)

Accessories



413 S

Accessory	Optional accessory
 <p>Rotor Ø 280, 60-50-(40) cm 16 spikes Quickfit included (can be reduced to 40 cm with kit 69210259)</p>	 <p>Support wheel Z0020368</p>  <p>Rear-mounted furrowing tool L0009800</p>
 <p>Rotor Ø 320, (80)-70-60-(50) cm 20 spikes Quickfit included Support wheel included (expandable to 80 cm with kit 69210231) (can be reduced to 50 cm with kit 69210229)</p>	 <p>Rear-mounted furrowing tool L0009800</p>
 <p>Rotor Ø 320, 80-70-60-(50) cm 24 spikes Quickfit included Support wheel included (can be reduced to 50 cm with kit 69210229)</p>	 <p>Rear-mounted furrowing tool L0009800</p>
 <p>Rotor Ø 320, (80)-70-60-(50) cm 20 spikes Fixed coupling Support wheel included (expandable to 80 cm with kit 69210231) (can be reduced to 50 cm with kit 69210229)</p>	 <p>Rear-mounted furrowing tool L0009800</p>





























Accessories

Accessory		Optional accessory		
Tyred wheels				
 <p>Pair of tyred wheels 4.00x8" Fixed disc</p>	69209025B	 <p>Screw-adjustable half-shafts</p>	69209105	
		 <p>5-hole adjustable half-shafts</p>	L0059500	
		 <p>Pair of spacers L 50 mm</p>	69209094	
		 <p>Pair of snow chains</p>	L1055015	
 <p>Pair of tyred wheels 4.00x10" Fixed disc</p>	69200024A	 <p>Screw-adjustable half-shafts</p>	69209105	
		 <p>5-hole adjustable half-shafts</p>	L0059500	
		 <p>Pair of spacers L 50 mm</p>	69209094	
		 <p>Pair of snow chains</p>	L0021600	
 <p>Pair of tyred wheels 4.00x10" Adjustable disc</p>	69209004B	 <p>Pair of 15 kg ballasts (not compatible with adjustable half-shafts)</p>	69209099	
		 <p>Pair of 15 kg ballasts (compatible with adjustable half-shafts)</p>	69209075	
		 <p>Screw-adjustable half-shafts</p>	69209105	
		 <p>5-hole adjustable half-shafts</p>	L0059500	
		 <p>Pair of spacers L 50 mm</p>	69209094	
		 <p>Pair of snow chains</p>	L0021600	
 <p>Pair of tyred wheels 5.00x10" Adjustable disc</p>	69209003B	 <p>Pair of 15 kg ballasts (not compatible with adjustable half-shafts)</p>	69209099	
		 <p>Pair of 15 kg ballasts (compatible with adjustable half-shafts)</p>	69209075	
		 <p>Screw-adjustable half-shafts</p>	69209105	
		 <p>5-hole adjustable half-shafts</p>	L0059500	
		 <p>Pair of spacers L 50 mm</p>	69209094	
		 <p>Pair of snow chains</p>	L0030200	
 <p>Pair of tyred wheels 16-6.50x8" Fixed disc</p>	69209012A	 <p>Screw-adjustable half-shafts</p>	69209105	
		 <p>5-hole adjustable half-shafts</p>	L0059500	

Accessories



413 S

Accessory		Optional accessory			
Steel wheels					
	Pair of steel wheels Ø 480x100 mm	69209067		Pair of width adjustment rings W 100 mm	L0040100
				Screw-adjustable half-shafts	69209105
				5-hole adjustable half-shafts	L0059500
				Pair of spacers L 50 mm	69209094
Adjustable tool holder					
	Adjustable tool holder	L1055001A		Single share plough	Z0020102
				180° turnwrest plough	Z0020104
				Furrowing tool	Z0020133
				Fixed-tine cultivator	L0010200
				Potato digger	L0066400
Drives and Cutter plates					
	Oil-immersed drive	69229096		0.95 m Complete central cutter plate Semi-fine teeth	69229084A
				1.15 m Complete central cutter plate Semi-fine teeth	69229085A
				1.27 m Complete central cutter plate Semi-fine teeth	69229086A
				1.40 m Complete central cutter plate Semi-fine teeth	69229087A
				0.95 m Complete central cutter plate Special teeth Side protection discs	69229068A
				1.15 m Complete central cutter plate Special teeth Side protection discs	69229069A
				1.27 m Complete central cutter plate Special teeth Side protection discs	69229070A
				1.40 m Complete central cutter plate Special teeth Side protection discs	69229071A
				1.22 m Complete central cutter plate "UNIVERSAL" ESM (requires kit L0058900)	69229036
				1.42 m Complete central cutter plate "UNIVERSAL" ESM (requires kit L0058900)	69229021
				1.02 m Complete central cutter plate "KOMUNAL" ESM (requires kit L0058900)	L0066900
				1.22 m Complete central cutter plate "KOMUNAL" ESM (requires kit L0058900)	69229037
				1.42 m Complete central cutter plate "KOMUNAL" ESM (requires kit L0058900)	69229038
				Ballast for oil-immersed drive	L0105700
	Directional guides for semi-fine tooth cutter plate	69229098			



Accessories

Accessory		Optional accessory		
Front shovel				
	<p>Front shovel L 100x40 cm Quickfit coupling With horizontal and vertical adjustment (requires QuickFit 69212006)</p>	69209065		
Snow thrower				
	<p>Turbine L 60 cm Two stages Adjustable ejector chute Quickfit coupling (requires QuickFit 69212006)</p>	L0026200		
Front brush				
	<p>Brush L 100xØ 35 cm With horizontal and vertical adjustment Quickfit coupling (requires QuickFit 69212006)</p>	L0094200		
Rotor type flail mower				
	<p>Flail mower L 65 cm 24 'Y' shaped knives Integral safety brake Quickfit coupling (requires QuickFit 69212006)</p>	L0091000		
Trailer				
	<p>Towed trailer with handlebar steering Load box dimensions 1.25x0.95 m Load box depth 30 cm Wheels 145x70-8" Max load capacity 300 kg Pedal operated brake Parking handbrake Dump box Collapsible tailgate (not homologated for road use)</p>	L0018601		
QuickFit				
	QuickFit coupling	69212006		

Professional two wheel tractor

417 S



Professional machine with power rating and features that recommend it for root crop harvesting and tillage duties on all terrain types. Combines exceptional ease of handling and versatility with the ability to work on all types of terrain safely, thanks to the self-locking differential and 5-speed gearbox.



The EHS system ensures ease of use, reduced effort and the maximum simplification for users.



Multidisc version supplied as standard with Giugiaro design cowling.



Two power take-offs, one independent two-speed PTO and one synchronised PTO.

417 S

Power supply	Engine	Model	Displacement	Power	Starting	Notes	Code
gasoline	POWERED BY HONDA	GX 340 OHV	389 cm ³	10.7 HP	recoil start	multidisc clutch	68339100AEN
gasoline	KOHLER	CH 395 OHV	277 cm ³	9.5 HP	recoil start/ electric	multidisc clutch/ battery supplied as standard	68339116AEN
gasoline	KOHLER	CH 440 OHV	429 cm ³	14.0 HP	recoil start/ electric	mono-disc clutch/ battery supplied as standard	68339117AEN
diesel	LOMBARDINI A KOHLER COMPANY	15LD440	441 cm ³	10.9 HP	recoil start	multidisc clutch	68339105AEN
diesel	LOMBARDINI A KOHLER COMPANY	15LD440	441 cm ³	10.9 HP	recoil start/ electric	multidisc clutch/ battery supplied as standard	68339101AEN
diesel	LOMBARDINI A KOHLER COMPANY	15LD440	441 cm ³	10.9 HP	recoil start/ electric	mono-disc clutch/ lights/ battery supplied as standard	68339120EN
diesel	LOMBARDINI A KOHLER COMPANY	3LD510	505 cm ³	12.2 HP	recoil start	mono-disc clutch	68339102EN
diesel	LOMBARDINI A KOHLER COMPANY	3LD510	505 cm ³	12.2 HP	electric	mono-disc clutch/ battery supplied as standard	68339103EN
diesel	LOMBARDINI A KOHLER COMPANY	3LD510	505 cm ³	12.2 HP	electric	mono-disc clutch/ lights/ battery supplied as standard	68339104EN

Focus on accessories



Rotor Ø 350, 80-65 cm
16 spikes
Fixed coupling
Support wheel included
Code **69219077**



Adjustable tool holder
Code **Z0020172**



Single share plough
Code **Z0020102**



WITH TWO WHEEL TRACTOR

Gearbox/ Speed (km/h):

5-speed (4 forward + 1 reverse) with 6.50/80-12" wheels

Speed (km/h)	1.08	1	1R	2.82
	2.02	2		
	3.61	3		
	7.91	4		

Dimensions (mm)

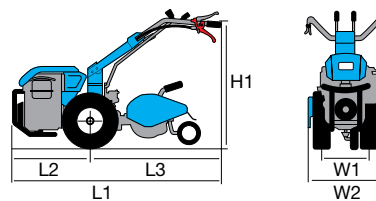

L1	2180
L2	730
L3	1450
H1	600-1300
W1	420-510
W2	600-900

WITH CUTTERBAR MOWER

Gearbox/ Speed (km/h):

5-speed (4 forward + 1 reverse) with 6.50/80-12" wheels

Speed (km/h)	1.08	1	1R	2.82
	2.02	2		
	3.61	3		
	7.91	4		

Dimensions (mm)

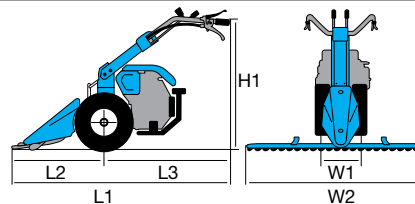

L1	2185
L2	1125
L3	1060
H1	700-1300
W1	430-490
W2	1150-1600

Transmission	with oil-bath gearbox
Clutch	dry multidisc or mono-disc
Handlebars	with vertical and horizontal adjustment and 180° reversible, with vibration-damping device
Reverse gear	yes, with lever alongside gearbox
Differential	yes
Brakes	yes
Power take-off	2 power take-offs: one independent 2-speed PTO (1° 540 rpm - 2° 900 rpm) and one synchronised PTO
Accessories installation	with flange on PTO
Towing hitch	yes
Cowling	yes, with integral tool compartment/battery box
Weight	250 kg (with diesel engine, rotor and wheels)

Accessories



















417 S

Accessory	Optional accessory			
Rotors for engines < 11 HP				
 <p>Rotor Ø 320, (80)-70-60-(50) cm 20 spikes Fixed coupling Support wheel included (expandable to 80 cm with kit 69210231) (can be reduced to 50 cm with kit 69210229)</p>	69219070		Rear-mounted furrowing tool	L0009800
 <p>Rotor Ø 320, 80-70-60-(50) cm 24 spikes Fixed coupling Support wheel included (can be reduced to 50 cm with kit 69210229)</p>	69219068		Rear-mounted furrowing tool	L0009800
Rotors for engines > 11 HP				
 <p>Rotor Ø 350, 80-65 cm 20 spikes Fixed coupling Support wheel included</p>	69219076		Rear-mounted furrowing tool	Z0020134
 <p>Rotor Ø 350, 80-65 cm 16 spikes Fixed coupling Support wheel included</p>	69219077		Rear-mounted furrowing tool	Z0020134

Accessories



Accessory		Optional accessory		
Tyred wheels				
 <p>Pair of tyred wheels 5.00x10" Adjustable disc</p>	69209003B		Pair of 15 kg ballasts (not compatible with adjustable half-shafts)	69209099
			Pair of 15 kg ballasts (compatible with adjustable half-shafts)	69209075
			Screw-adjustable half-shafts	69209105
			5-hole adjustable half-shafts	L0059500
			Pair of spacers L 95 mm	69209095
			Pair of snow chains	L0030200
 <p>Pair of tyred wheels 5.00x12" Adjustable disc</p>	69209002B		Pair of ballasts 25 kg (compatible with adjustable half-shafts)	69209077
			Screw-adjustable half-shafts	69209105
			5-hole adjustable half-shafts	L0059500
			Pair of spacers L 95 mm	69209095
 <p>Pair of tyred wheels 6.5/80x12" Adjustable disc</p>	69200038B		Pair of ballasts 25 kg (compatible with adjustable half-shafts)	69209077
			Screw-adjustable half-shafts	69209105
			5-hole adjustable half-shafts	L0059500
			Pair of spacers L 95 mm	69209095

Accessories



417 S

Accessory		Optional accessory		
Steel wheels				
 <p>Pair of steel wheels Ø 570x125 mm</p>	69209068		Pair of width adjustment rings W 100 mm	69209069
			Screw-adjustable half-shafts	69209105
			5-hole adjustable half-shafts	L0059500
			Pair of spacers L 95 mm	69209095
Adjustable tool holder				
 <p>Adjustable tool holder</p>	Z0020172		Single share plough	Z0020102
			180° turnwrest plough	Z0020104
			Furrowing tool	Z0020133
			Fixed-tine cultivator (not compatible with 5.00x10" wheels)	L0010200
			Potato digger (not compatible with 5.00x10" wheels)	L0066400
Drives and Cutter plates				
 <p>Oil-immersed drive</p>	L0101500		1.15 m Complete central cutter plate Semi-fine teeth	69229085A
			1.27 m Complete central cutter plate Semi-fine teeth	69229086A
			1.40 m Complete central cutter plate Semi-fine teeth	69229087A
			0.95 m Complete central cutter plate Special teeth Side protection discs	69229068A
			1.15 m Complete central cutter plate Special teeth Side protection discs	69229069A
			1.27 m Complete central cutter plate Special teeth Side protection discs	69229070A
			1.40 m Complete central cutter plate Special teeth Side protection discs	69229071A
			1.22 m Complete central cutter plate "UNIVERSAL" ESM (requires kit L0058900)	69229036
			Ballast for oil-immersed drive	L0105700
	Directional guides for semi-fine tooth cutter plate	69229098		
Lighting				
 <p>Supplementary worklight kit (versions with electric starting only)</p>	69209113			



Professional two wheel tractor

418 S



Its characteristics of high power and reliability make this model perfect for farmers and ground care professionals. Combines exceptional ease of handling and versatility with the ability to work on all types of terrain safely, thanks to the self-locking differential and 5-speed gearbox. The powerful engines available for this model are exploited in full thanks to the reinforced half-shafts, while the large size final reduction gears on the axle ensure efficient transmission of the full engine power while increasing the machine's ground clearance.



Reinforced half-shafts with final reduction drives incorporated in the transmission assembly for more grip on difficult terrain.



Two power take-offs, one independent two-speed PTO and one synchronised PTO.



Accessories coupling by means of flange on the PTO.

418 S

Power supply	Engine	Model	Displacement	Power	Starting	Notes	Code
diesel	LOMBARDINI	3LD510	505 cm ³	12.2 HP	electric	mono-disc clutch/ lights/ battery supplied as standard	68339153AEN
diesel	LOMBARDINI	25LD330	654 cm ³	16.3 HP	electric	mono-disc clutch/ lights/ battery supplied as standard	68339154AEN
diesel	LOMBARDINI	25LD425	851 cm ³	19.0 HP	electric	mono-disc clutch/ lights/ battery supplied as standard	68339155AEN

Focus on accessories



Rotor Ø 350, 80-65 cm
16 spikes
Fixed coupling
Support wheel
Code **69219077**



Adjustable tool holder
Code **Z0020172**



180° turnwrest plough
Code **Z0020107**



WITH TWO WHEEL TRACTOR

Gearbox/ Speed (km/h):

5-speed (4 forward + 1 reverse) with 6.50/80-12" wheels

Speed (km/h)	1.08	1	1R	2.82
	2.02	2		
	3.61	3		
	7.91	4		

Dimensions (mm)

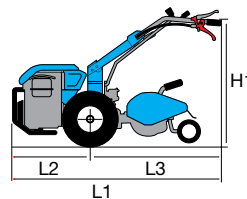

L1	2180
L2	730
L3	1450
H1	600-1300
W1	420-510
W2	600-900

WITH CUTTERBAR MOWER

Gearbox/ Speed (km/h):

5-speed (4 forward + 1 reverse) with 6.50/80-12" wheels

Speed (km/h)	1.08	1	1R	2.82
	2.02	2		
	3.61	3		
	7.91	4		

Dimensions (mm)

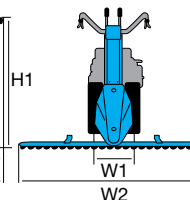
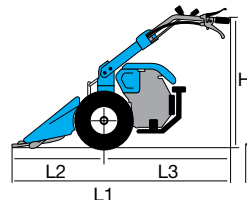

L1	2185
L2	1125
L3	1060
H1	700-1300
W1	450-510
W2	1150-1600

Transmission	with oil-bath gearbox
Clutch	dry mono-disc
Handlebars	with vertical and horizontal adjustment and 180° reversible, with vibration-damping device
Reverse gear	yes, with lever alongside gearbox
Differential	yes
Brakes	yes
Power take-off	2 power take-offs one independent 2-speed PTO (1° 540 rpm - 2° 900 rpm) and one synchronised PTO
Accessories installation	flanged to PTO
Towing hitch	yes
Cowling	yes, with integral tool compartment/battery box
Weight	270 kg (with diesel engine, rotor and wheels)

Accessories



















418 S

Accessory		Optional accessory		
Rotors				
	Rotor Ø 350, 80-65 cm 20 spikes Fixed coupling Support wheel	69219076		Rear-mounted furrowing tool Z0020134
	Rotor Ø 350, 80-65 cm 16 spikes Fixed coupling Support wheel	69219077		Rear-mounted furrowing tool Z0020134
	Rotor Ø 350, 80-65 cm 20 spikes Fixed coupling with tiller shaft adapter Support wheel (compatible with 6.50/80-15" wheels only)	69219104		Rear-mounted furrowing tool Z0020134
	Rotor Ø 350, 80-65 cm 16 spikes Fixed coupling with tiller shaft adapter Support wheel (compatible with 6.50/80-15" wheels only)	69219105		Rear-mounted furrowing tool Z0020134
	Rotor Ø 350, 90-65 cm 16 spikes Fixed coupling with tiller shaft adapter Support wheel (compatible with 6.50/80-15" wheels only)	69219106		Rear-mounted furrowing tool Z0020134
Tyred wheels				
	Pair of tyred wheels 6.5/80x12" Adjustable disc	69200038B		Pair of ballasts 25 kg (compatible with adjustable half-shafts) 69209077
				Screw-adjustable half-shafts 69209105
				5-hole adjustable half-shafts L0059500
				Pair of spacers L 95 mm 69209095
	Pair of tyred wheels 6.5/80x15" Adjustable disc	69209013		Pair of ballasts 25 kg 69209077



Accessories

Accessory		Optional accessory		
Adjustable tool holder				
 <p>Adjustable tool holder</p>	<p>Z0020172</p>		Single share plough	Z0020102
			180° turnwrest plough	Z0020107
			Furrowing tool	Z0020133
			Fixed-tine cultivator	L0010200
			Potato digger	L0066400
Drives and Cutter plates				
 <p>Oil-immersed drive</p>	<p>L0101500</p>		<p>1.15 m Complete central cutter plate Semi-fine teeth</p>	69229085A
			<p>1.27 m Complete central cutter plate Semi-fine teeth</p>	69229086A
			<p>1.40 m Complete central cutter plate Semi-fine teeth</p>	69229087A
			<p>0.95 m Complete central cutter plate Special teeth Side protection discs</p>	69229068A
			<p>1.27 m Complete central cutter plate Special teeth Side protection discs</p>	69229070A
			<p>1.40 m Complete central cutter plate Special teeth Side protection discs</p>	69229071A
			<p>1.22 m Complete central cutter plate "UNIVERSAL" ESM (requires kit L0058900)</p>	69229036
			Ballast for oil-immersed drive	L0105700
			Directional guides for semi-fine tooth cutter plate	69229098

Professional machines for shredding and chopping grass, shoots and green waste generally, powerful and reliable for finishing jobs.



Flail mowers

PROFESSIONAL



BTS 65



BTS 80



TECHNICAL DATA



gearbox



power



knives



working width

Professional flail mower

BTS 65



High-performance, reliable model designed for the needs of farmers and professional operators. Grass, shoots, twigs and low vegetation, scrub and stubble: this machine stops at nothing, assuring excellent cleaning of ground, orchards and vineyards thanks to its highly efficient and powerful cutting unit and wide working width.



Independent steering clutches on the driving wheels, with wheel lock, which make the machine extremely easy to handle.



The handlebars have 4 vertical adjustment positions and 5 horizontal adjustment positions.



The front directional wheels can be locked to facilitate work on sloping surfaces.

BTS 65

Power supply	Engine	Model	Displacement	Power	Starting	Code
gasoline	POWERED by HONDA	GX 340 OHV	389 cm ³	10.7 HP	recoil start	68249007

Focus on accessories



Pair of steel wheels + Width adjustment ring
Steel wheels Ø 410 mm
Code **68242001**



Gearbox/ Speed (km/h):

4-speed (3 forward + 1 reverse) with 16/6.50-8" wheels

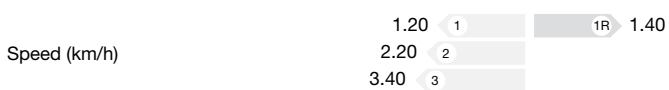

Dimensions (mm)

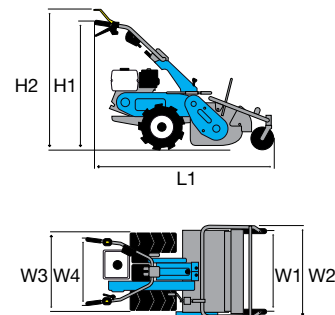

L1	1657
H1	1092
H2	1216
W1	700
W2	814
W3	670
W4	550

Transmission	with oil-bath gearbox
Clutch	belt with tensioner
Steering	with independent steering clutches and wheel lock
Handlebars	with vertical and horizontal adjustment
Cutting unit	rotor with 38 'Y' shaped knives
Working width	65 cm
Cutting height	20 to 80 mm, adjustable with handle
Service brake	with automatic engagement
Front wheels	swivel with lock
Rear wheels	16/6.50-8"
Weight	160 kg

Professional flail mower

BTS 80



High-performance, extremely reliable machine offering the same professional performance as the smaller model, with a more powerful engine and greater cutting width for excellent results under all conditions.



Rotor with powerful and sturdy 'Y' shaped knives to cut and shred grass and clippings efficiently with no risk of impact or damage.



The gear selection lever on the handlebar is simple to operate.



The service and parking brake engages automatically when the clutch is released, to prevent accidental hazardous movements.

BTS 80

Power supply	Engine	Model	Displacement	Power	Starting	Code
gasoline	POWERED by HONDA	GX 340 OHV	389 cm ³	10.7 HP	recoil start	68249018A

Focus on accessories



Pair of steel wheels + Width adjustment ring
Steel wheels Ø 410 mm
Code **68242001**



Gearbox/ Speed (km/h):

4-speed (3 forward + 1 reverse) with 16/6.50-8" wheels

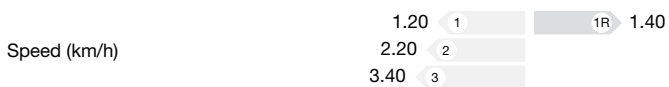

Dimensions (mm)

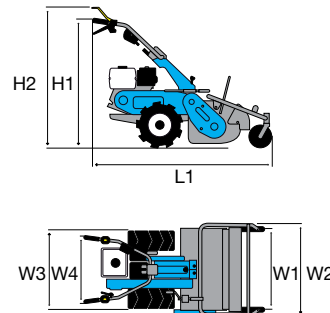

L1	1657
H1	1092
H2	1216
W1	850
W2	964
W3	670
W4	550

Transmission	with oil-bath gearbox
Clutch	belt with tensioner
Steering	with independent steering clutches and wheel lock
Handlebars	with vertical and horizontal adjustment
Cutting unit	rotor with 46 'Y' shaped knives
Working width	80 cm
Cutting height	20 to 80 mm, adjustable with handle
Service brake	with automatic engagement
Front wheels	swivel with lock
Rear wheels	16/6.50-8"
Weight	175 kg

Easy to steer and handle for
a precise cut and
consistently high performance
in all working conditions.



Cutterbar mowers

HOME



110



120



INTENSIVE



130 S

NEW



140



PROFESSIONAL



141



141 M



TECHNICAL DATA



gearbox



power



cutter bar



differential block



reverse gear



brakes



half-shafts with reduction gears

OPTIONAL



cutter bar



brush



turbine



shovel



flail mower

Cutterbar mower for home use

110



Configured for a centrally mounted cutterbar, this lightweight and manoeuvrable machine is designed to meet the requirements of non-professional users. The machine is primarily used to cut grass and fodder crops and for general clearing duties outside the garden.



Handlebars with vertical adjustment to allow the operator to assume the correct posture while working.



Handlebar mounted on vibration dampers.



Integral QuickFit coupling that allows the operator to change the tools without using tools.

110

Power supply	Engine	Model	Displacement	Power	Starting	Code
gasoline	Emak	K 700 H OHV	182 cm ³	5.4 HP	recoil start	68939001EN

Focus on accessories



Pair of treaded wheels 3.50x6"
Fixed disc
Code **69209107**



Cam drive
Code **69222010**



Complete central cutter plate
0.92 m
Special teeth
Code **69222011**



Gearbox/ Speed (km/h):

1-speed (1 forward) with 3.50-6" wheels

Speed (km/h)

2.30 1

Dimensions (mm)

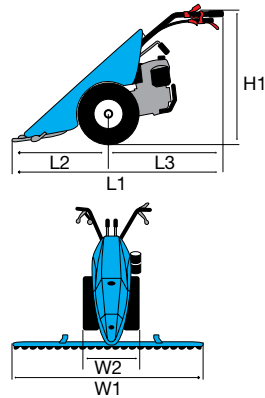

L1	1540
L2	740
L3	800
H1	990
W1	920
W2	400

Transmission	with oil-bath gearbox
Clutch	direct engagement
Handlebars	with vertical adjustment and anti-vibration device
Reverse gear	no
Differential	no
Brakes	no
Power take-off	independent 1017 rpm
Accessories installation	QuickFit supplied as standard
Weight	70 kg (with wheels, bar drive and cutter)

Cutterbar mower for home use

120



The machine is primarily used to cut grass and fodder crops and for general field clearing duties. Features such as the vertically and horizontally adjustable handlebars, the QuickFit system, and transmission available also with oil-immersed drive reflect the high level of attention paid to the operator.



Handlebar-mounted PTO control.



Handlebars with vertical and horizontal adjustment and vibration-damping device to assure more comfortable handling.



Integral QuickFit coupling that allows the operator to change the tools without using tools.

120

Power supply	Engine	Model	Displacement	Power	Starting	Code
gasoline	POWERED BY HONDA	GX 160 OHV	163 cm ³	4.8 HP	recoil start	68919127
gasoline	Emak	K 800 H OHV	182 cm ³	5.7 HP	recoil start	68919131
gasoline	KOHLER	CH 270 OHV	208 cm ³	7.0 HP	recoil start	68919126

Focus on accessories



Cam drive
Code **69229091**



Complete central cutter plate
0.92 m
Special teeth
Code **69222011**



Brush L 80-Ø 35 cm
With horizontal and vertical adjustment
Code **L0070000**



Gearbox/ Speed (km/h):

2-speed (1 forward + 1 reverse) with 4.00-8" wheels

Speed (km/h)

3.07 **1** **1R** 1.18

Dimensions (mm)

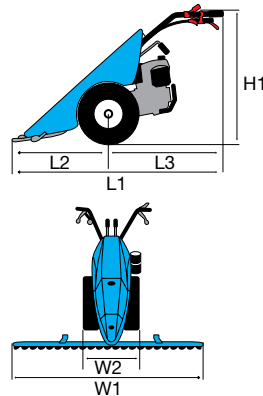

L1	1465
L2	600
L3	865
H1	1150
W1	920-1220
W2	465

Transmission	with oil-bath gearbox
Clutch	dry multidisc
Handlebars	with vertical and horizontal adjustment and anti-vibration device
Reverse gear	no
Differential	no
Brakes	no
Power take-off	independent 1004 rpm
Accessories installation	QuickFit supplied as standard
Weight	80 kg (with wheels, bar drive and cutter)

Accessories



120

Accessory		Optional accessory		
Tyred wheels				
	Pair of tyred wheels 4.00x8" Fixed disc	69209025B		Pair of snow chains L1055015
Steel wheels				
	Pair of steel wheels Ø 480x100 mm (installable directly on the hubs or in combination with wheels 69209025B)	69209067		Pair of width adjustment rings W 100 mm L0040100
Drives and Cutter plates				
	Cam drive	69229091		0.92 m Complete central cutter plate Special teeth 69222011
	Oil-immersed drive	69229028		0.95 m Complete central cutter plate Semi-fine teeth 692229084A
				1.15 m Complete central cutter plate Semi-fine teeth 692229085A
				0.95 m Complete central cutter plate Special teeth Side protection discs 692229068A
				1.15 m Complete central cutter plate Special teeth Side protection discs 692229069A
				1.22 m Complete central cutter plate "UNIVERSAL" ESM (requires kit L0058900) 69229036
				1.02 m Complete central cutter plate "KOMUNAL" ESM (requires kit L0058900) L0066900
				1.22 m Complete central cutter plate "KOMUNAL" ESM (requires kit L0058900) 69229037
				Directional guides for semi-fine tooth cutter plate 69229098
				Ballast for oil-immersed drive L0105700
Front brush				
	Brush L 80-Ø 35 cm With horizontal and vertical adjustment	L0070000		



Cutterbar mower for intensive use

130 S

NEW



Designed for use in small and medium-sized plots, in a highly effective and reliable manner this machine combines professional level features and performance with exceptional manoeuvrability, making it ideal for demanding home users and smallholders. The wide range of accessories available, including cutter bars, brushes and snow throwers, meet the requirements of those who are seeking a multifunctional machine that's easy to use and completely safe.



Handlebars with vertical and horizontal adjustment and vibration-damping device for more comfortable use of the machine.



The EHS system ensures ease of use, reduced effort and the maximum simplification for users.



Practical forward/reverse shuttle enables the operator to select reverse quickly from any speed. This feature makes the machine exceptionally manoeuvrable in various different work activities.

130 S

Power supply	Engine	Model	Displacement	Power	Starting	Code
gasoline	POWERED BY HONDA	GX 200 OHV	196 cm ³	5.8 HP	recoil start	68949002EN
gasoline	Emak	K 800 H OHV	182 cm ³	5.7 HP	recoil start	68949001EN

Focus on accessories



Brush L 100xØ 35 cm
With horizontal and vertical adjustment
Quickfit coupling
Code **L0094200**



Oil-immersed drive
Code **69229096**



Front shovel L 100x40 cm
Quickfit coupling
With horizontal and vertical adjustment
Code **69209065**



Gearbox/ Speed (km/h):

4-speed (2 forward + 2 reverse) with 4.00-8" wheels

Speed (km/h)

1.11	1	1R	1.05
2.32	2	2R	2.20

Dimensions (mm)

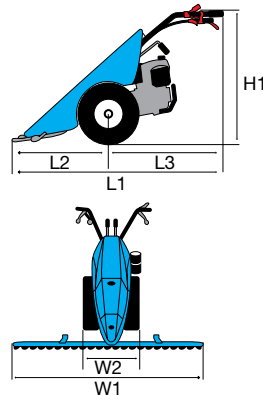



















L1	1670
L2	900
L3	770
H1	1250-300
W1	1270-950
W2	450

Transmission	with oil-bath gearbox
Clutch	dry bevel type
Handlebars	with vertical and horizontal adjustment and vibration-damping device
Reverse gear	yes, with handlebar lever
Differential	no
Brakes	no
Power take-off	independent 973 rpm
Accessories installation	QuickFit supplied as standard
Weight	105 kg (with wheels, bar drive and cutter)

Accessories



130 S

Accessory		Optional accessory	
Tyred wheels			
	Pair of tyred wheels 4.00x8" Fixed disc Quickfit coupling	69209110	 Pair of snow chains L1055015
	Pair of tyred wheels 4.00x10" Fixed disc (requires spacers 69209112)	69200024A	 Pair of snow chains L0021600
Steel wheels			
	Pair of steel wheels Ø 480x100 mm (requires spacers 69209112)	69209067	 Pair of width adjustment rings W 100 mm L0040100
Drives and Cutter plates			
 Oil-immersed drive	69229096		0.95 m Complete central cutter plate Semi-fine teeth 69229084A
			1.15 m Complete central cutter plate Semi-fine teeth 69229085A
			1.27 m Complete central cutter plate Semi-fine teeth 69229086A
			0.95 m Complete central cutter plate Special teeth Side protection discs 69229068A
			1.15 m Complete central cutter plate Special teeth Side protection discs 69229069A
			1.27 m Complete central cutter plate Special teeth Side protection discs 69229070A
			1.22 m Complete central cutter plate " UNIVERSAL " ESM (requires kit L0058900) 69229036
			1.02 m Complete central cutter plate " KOMUNAL " ESM (requires kit L0058900) L0066900
			1.22 m Complete central cutter plate " KOMUNAL " ESM (requires kit L0058900) 69229037
			Ballast for oil-immersed drive L0105700
			Directional guides for semi-fine tooth cutter plate 69229098



Accessories

Accessory		Optional accessory		
Front shovel				
 <p>Front shovel L 100x40 cm Quickfit coupling With horizontal and vertical adjustment</p>	69209065			
Snow thrower				
 <p>Turbine L 60 cm Two stages Adjustable ejector chute Quickfit coupling</p>	L0026200			
Front brush				
 <p>Brush L 100xØ 35 cm With horizontal and vertical adjustment Quickfit coupling</p>	L0094200			
Rotor type flail mower				
 <p>Flail mower L 65 cm 24 "Y" shaped knives Integral safety brake Quickfit coupling (requires QuickFit 69212006)</p>	L0091000			

Cutterbar mower for intensive use

140



Configured for a centrally mounted cutterbar, this lightweight and easy-to-handle machine was designed to satisfy the needs of semi-professional users. It is used mainly for cutting grass and forage crops and for field cleaning. Details including the height-adjustable handlebars, rapid forward/reverse shuttle, Quickfit system and optional oil-bath transmission all demonstrate the close attention paid to operator comfort and safety.



Rapid forward/reverse shuttle, controlled from the handlebar: used to invert the operating direction without touching the gears.



Integral QuickFit coupling that allows the operator to change the tools without using tools.



Handlebars with vertical adjustment and vibration-damping device to assure more comfortable handling.

140

Power supply	Engine	Model	Displacement	Power	Starting	Code
gasoline	POWERED BY HONDA	GX 160 OHV	163 cm ³	4.8 HP	recoil start	68919051
gasoline	POWERED BY HONDA	GX 270 OHV	270 cm ³	8.4 HP	recoil start	68919055
gasoline	KOHLER	CH 395 OHV	277 cm ³	9.5 HP	recoil start	68919059A

Focus on accessories



Oil-immersed drive
Code **69229023**



Front shovel L 100x40 cm
Quickfit coupling
With horizontal and vertical adjustment
Code **69209065**



Brush L 100xØ 35 cm
With horizontal and vertical adjustment
Quickfit coupling
Code **L0094200**



Gearbox/ Speed (km/h):

7-speed (4 forward + 3 reverse) with 4.00-8" wheels

Speed (km/h)	1.05	1	1R	1.11
	2.20	2	2R	2.32
	3.63	3	3R	3.83
	11.38	4		

Dimensions (mm)

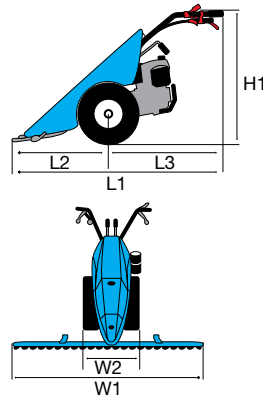



















L1	1660 (1665)
L2	900 (950)
L3	760
H1	1250-400
W1	950-1450
W2	437

Transmission	with oil-bath gearbox
Clutch	dry multidisc
Handlebars	with vertical adjustment and anti-vibration device
Reverse gear	yes, with handlebar lever
Differential	no
Brakes	no
Power take-off	independent 973 rpm
Accessories installation	QuickFit supplied as standard
Weight	115 kg (with wheels, bar drive and cutter)

















Accessories



140

Accessory		Optional accessory		
Tyred wheels				
	Pair of tyred wheels 4.00x8" Fixed disc	69209025B		Pair of spacers L 50 mm 69209094
				Pair of spacers L 130 mm For fitting twin wheels 69209097
				Pair of snow chains L0021600
	Pair of tyred wheels 4.00x10" Fixed disc	69200024		Pair of spacers L 50 mm 69209094
				Pair of spacers L 130 mm For fitting twin wheels 69209097
				Pair of snow chains L0021600
	Pair of tyred wheels 4.00x10" Adjustable disc	69209004B		Pair of spacers L 50 mm 69209094
				Pair of spacers L 130 mm For fitting twin wheels 69209097
				Pair of tyre crampons 10" L0033800
				Pair of snow chains L0021600
	Pair of tyred wheels 5.00x10" Adjustable disc	69209003B		Pair of spacers L 50 mm (required for DIESEL engines) 69209094
				Pair of spacers L 150 mm For fitting twin wheels 69209098
				Pair of snow chains L0030200
	Pair of tyred wheels 16-6.50/8" Fixed disc	69209012A		Pair of spacers L 50 mm (required for assembly) 69209094
	Pair of tyred wheels 18-9.50/8" Fixed disc	69209104		Pair of spacers L 100 mm (required for assembly) 69209103
Steel wheels				
	Pair of steel wheels Ø 480x100 mm	69209067		Pair of width adjustment rings W 100 mm L0040100



Accessory	Optional accessory			
 <p>Oil-immersed drive</p>	69229023		<p>0.95 m Complete central cutter plate Semi-fine teeth</p>	69229084A
			<p>1.15 m Complete central cutter plate Semi-fine teeth</p>	69229085A
			<p>1.27 m Complete central cutter plate Semi-fine teeth</p>	69229086A
			<p>1.40 m Complete central cutter plate Semi-fine teeth</p>	69229087A
			<p>0.95 m Complete central cutter plate Special teeth Side protection discs</p>	69229068A
			<p>1.15 m Complete central cutter plate Special teeth Side protection discs</p>	69229069A
			<p>1.27 m Complete central cutter plate Special teeth Side protection discs</p>	69229070A
			<p>1.40 m Complete central cutter plate Special teeth Side protection discs</p>	69229071A
			<p>1.22 m Complete central cutter plate "UNIVERSAL" ESM (requires kit L0058900)</p>	69229036
			<p>1.42 m Complete central cutter plate "UNIVERSAL" ESM (requires kit L0058900)</p>	69229021
			<p>1.02 m Complete central cutter plate "KOMUNAL" ESM (requires kit L0058900)</p>	L0066900
			<p>1.22 m Complete central cutter plate "KOMUNAL" ESM (requires kit L0058900)</p>	69229037
			<p>1.42 m Complete central cutter plate "KOMUNAL" ESM (requires kit L0058900)</p>	69229038
			<p>Directional guides for semi-fine tooth cutter plate</p>	69229098
			<p>Ballast for mechanical drive</p>	L0105500
	<p>Ballast for oil-immersed drive</p>	L0105700		

Accessories



140

Accessory		Optional accessory		
Front shovel				
 <p>Front shovel L 100x40 cm Quickfit coupling With horizontal and vertical adjustment</p>	69209065			
Snow thrower				
 <p>Turbine L 60 cm Two stages Adjustable ejector chute Quickfit coupling</p>	L0026200			
Front brush				
 <p>Brush L 100xØ 35 cm With horizontal and vertical adjustment Quickfit coupling</p>	L0094200			
Rotor type flail mower				
 <p>Flail mower L 65 cm 24 "Y" shaped knives Integral safety brake Quickfit coupling</p>	L0091000			



Professional cutterbar mower

141



The model 141 completes the semi-professional range: this is the ideal machine for mowing grass and forage crops or cleaning in open fields. With an excellent combination of power and easy handling, this cutterbar mower is fitted with independently controlled brakes as standard.



Independent brakes on each wheel supplied as standard.



Practical forward/reverse shuttle enables the operator to change quickly into reverse gear at any speed.



Differential supplied as standard, to facilitate manoeuvres, also on gradients.

141

Power supply	Engine	Model	Displacement	Power	Starting	Code
gasoline	POWERED BY HONDA	GX 270 OHV	270 cm ³	8.4 HP	recoil start	68919025
gasoline	KOHLER	CH 395 OHV	277 cm ³	9.5 HP	recoil start	68919030A
diesel	LOMBARDINI <small>by KOHLER COMPANY</small>	15LD350	349 cm ³	7.5 HP	recoil start	68919022

Focus on accessories



Oil-immersed drive
Code **69229023**

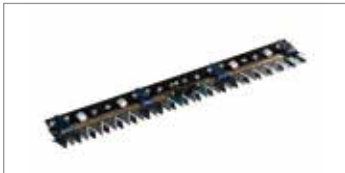

Complete central cutter plate
1.15 m
Special teeth
Side protection discs
Code **69229069A**



Turbine L 60 cm
Two stages
Adjustable ejector chute
Quickfit coupling
Code **L0026200**



Gearbox/ Speed (km/h):

7-speed (4 forward + 3 reverse) with 4.00-10" wheels

Speed (km/h)	1.20	1	1R	1.27
	2.57	2	2R	2.66
	4.17	3	3R	4.41
	13.05	4		

Dimensions (mm)

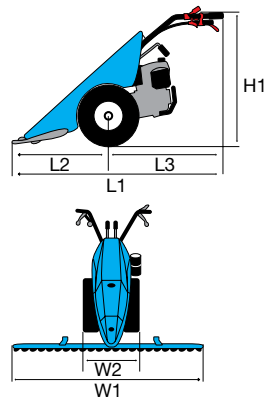

L1	1660 (1665)
L2	900 (950)
L3	760
H1	1255-405
W1	900-1600
W2	445-586

Transmission	with oil-bath gearbox
Clutch	dry multidisc
Handlebars	with vertical adjustment and anti-vibration device
Reverse gear	yes, with handlebar lever
Differential	yes
Brakes	yes
Power take-off	independent 973 rpm
Accessories installation	QuickFit supplied as standard
Weight	135 kg (with wheels, bar drive and cutter)

Accessories



















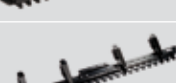

141

Accessory		Optional accessory		
Tyred wheels				
 <p>Pair of tyred wheels 4.00x10" Fixed disc</p>	69200024	 <p>Pair of spacers L 50 mm</p>	69209094	
		 <p>Pair of spacers L 130 mm For fitting twin wheels</p>	69209097	
		 <p>Pair of snow chains</p>	L0021600	
 <p>Pair of tyred wheels 4.00x10" Adjustable disc</p>	69209004B	 <p>Pair of spacers L 50 mm</p>	69209094	
		 <p>Pair of spacers L 130 mm For fitting twin wheels</p>	69209097	
		 <p>Pair of tyre crampons 10"</p>	L0033800	
		 <p>Pair of snow chains</p>	L0021600	
 <p>Pair of tyred wheels 5.00x10" Adjustable disc</p>	69209003B	 <p>Pair of spacers L 50 mm (required for DIESEL engines)</p>	69209094	
		 <p>Pair of spacers L 150 mm For fitting twin wheels</p>	69209098	
		 <p>Pair of snow chains</p>	L0030200	
 <p>Pair of tyred wheels 18-9.50/8" Fixed disc</p>	69209104	 <p>Pair of spacers L 100 mm (required for assembly)</p>	69209103	
Steel wheels				
 <p>Pair of steel wheels Ø 480x100 mm</p>	69209067	 <p>Pair of width adjustment rings W 100 mm</p>	L0040100	

Accessories







Accessory	Optional accessory		
 <p>Oil-immersed drive</p> <p>69229023</p>		<p>0.95 m Complete central cutter plate Semi-fine teeth</p>	<p>69229084A</p>
		<p>1.15 m Complete central cutter plate Semi-fine teeth</p>	<p>69229085A</p>
		<p>1.27 m Complete central cutter plate Semi-fine teeth</p>	<p>69229086A</p>
		<p>1.40 m Complete central cutter plate Semi-fine teeth</p>	<p>69229087A</p>
		<p>1.60 m Complete central cutter plate Semi-fine teeth</p>	<p>69229093A</p>
		<p>0.95 m Complete central cutter plate Special teeth Side protection discs</p>	<p>69229068A</p>
		<p>1.15 m Complete central cutter plate Special teeth Side protection discs</p>	<p>69229069A</p>
		<p>1.27 m Complete central cutter plate Special teeth Side protection discs</p>	<p>69229070A</p>
		<p>1.40 m Complete central cutter plate Special teeth Side protection discs</p>	<p>69229071A</p>
		<p>1.22 m Complete central cutter plate “UNIVERSAL” ESM (requires kit L0058900)</p>	<p>69229036</p>
		<p>1.42 m Complete central cutter plate “UNIVERSAL” ESM (requires kit L0058900)</p>	<p>69229021</p>
		<p>1.02 m Complete central cutter plate “KOMUNAL” ESM (requires kit L0058900)</p>	<p>L0066900</p>
		<p>1.22 m Complete central cutter plate “KOMUNAL” ESM (requires kit L0058900)</p>	<p>69229037</p>
		<p>1.42 m Complete central cutter plate “KOMUNAL” ESM (requires kit L0058900)</p>	<p>69229038</p>
		<p>Directional guides for semi-fine tooth cutter plate</p>	<p>69229098</p>
		<p>Ballast for mechanical drive</p>	<p>L0105500</p>
	<p>Ballast for oil-immersed drive</p>	<p>L0105700</p>	

Accessories



141

Accessory	Optional accessory			
Front shovel				
 <p>Front shovel L 100x40 cm Quickfit coupling With horizontal and vertical adjustment</p>	69209065			
Snow thrower				
 <p>Turbine L 60 cm Two stages Adjustable ejector chute Quickfit coupling</p>	L0026200			
Front brush				
 <p>Brush L 100xØ 35 cm With horizontal and vertical adjustment Quickfit coupling</p>	L0094200			
Rotor type flail mower				
 <p>Flail mower L 65 cm 24 "Y" shaped knives Integral safety brake Quickfit coupling</p>	L0091000			

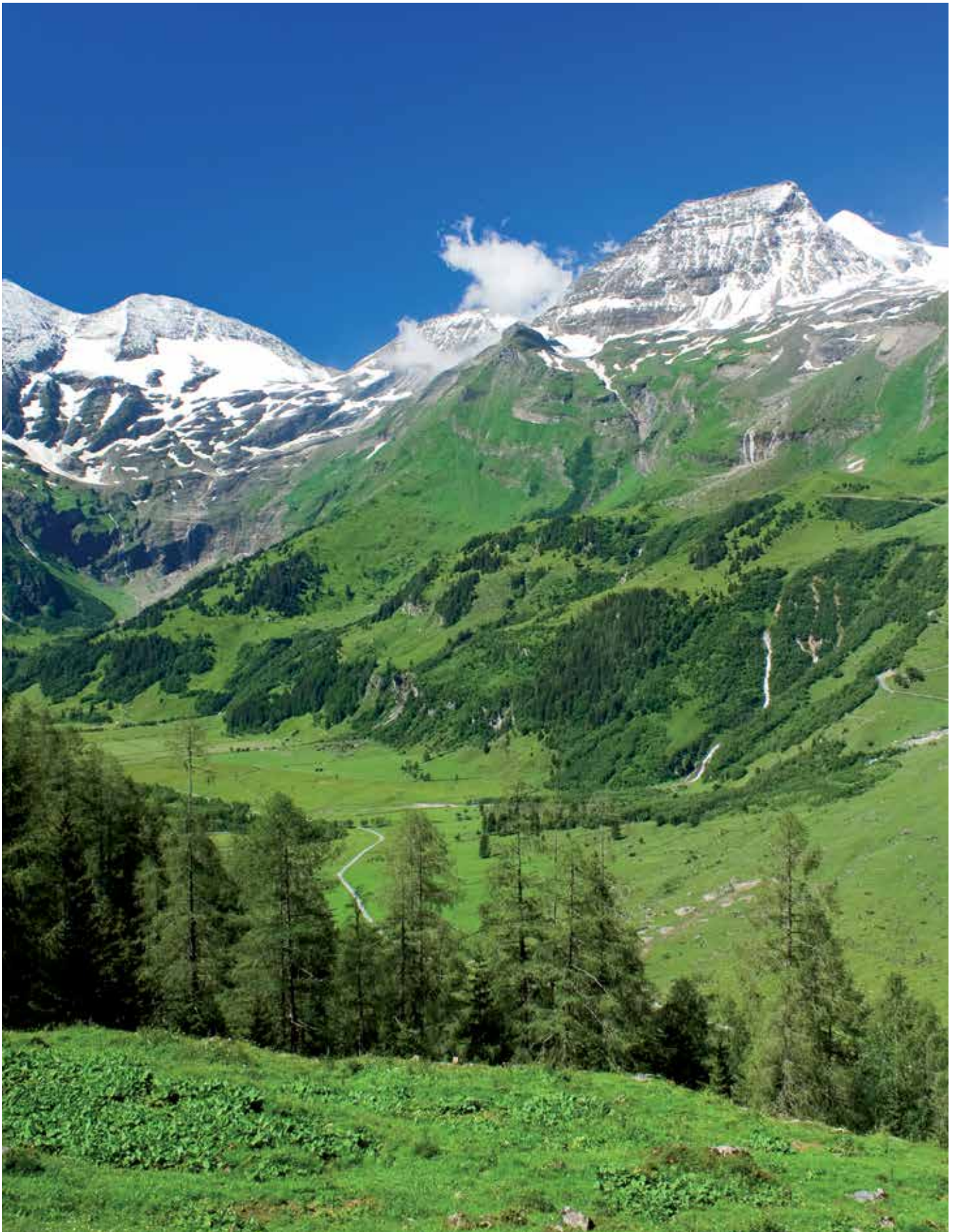

Professional cutterbar mower

141 M



Professional model ideal for use on mountainous terrain, for cutting grass, hay making and clearing fields: this is a powerful machine that's well suited to working on fields with a steep gradient.



Steering clutches with control in combination with the brakes allow the machine to be turned through 360° with a minimum turning radius.



Half-shafts with final reduction gears to improve grip on steep inclines.



Independently controlled brakes and parking brake.

141 M

Power supply	Engine	Model	Displacement	Power	Starting	Code
gasoline	KOHLER	CH 395 OHV	277 cm ³	9.5 HP	recoil start	68919083A
diesel	LOMBARDINI <small>by KOHLER COMPANY</small>	15LD350	349 cm ³	7.5 HP	recoil start	68919072

Focus on accessories



Oil-immersed drive
Code **69229023**



Complete central cutter plate
1.22 m
"KOMUNAL" ESM
(requires kit **L0058900**)
Code **69229037**



Pair of steel wheels
Ø 480x100 mm
Code **69209067**



Gearbox/ Speed (km/h):

7-speed (4 forward + 3 reverse) with 4.00-10" wheels

Speed (km/h)

1.20	1	1R	1.27
2.57	2	2R	2.66
4.17	3	3R	4.41
13.05	4		

Dimensions (mm)

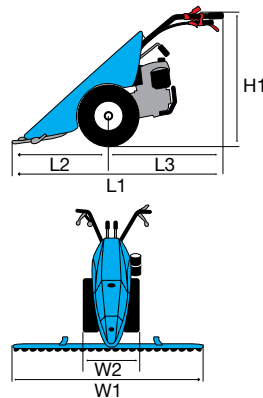









L1	1765
L2	950
L3	860
H1	1260-410
W1	1270-1620
W2	715-800

Transmission	with oil-bath gearbox
Clutch	dry multidisc
Handlebars	with vertical adjustment and anti-vibration device
Reverse gear	yes, with handlebar lever
Differential	yes, with steering clutches with controls combined with brakes
Brakes	yes
Power take-off	independent 973 rpm
Accessories installation	QuickFit supplied as standard
Weight	175 kg (with wheels, bar drive and cutter)

Accessories





















141 M

Accessory		Optional accessory		
Tyred wheels				
	Pair of tyred wheels 4.00x10" Fixed disc	69200024		Pair of spacers L 50 mm 69209094
				Pair of spacers L 130 mm For fitting twin wheels 69209097
				Pair of snow chains L0021600
	Pair of tyred wheels 4.00x10" Adjustable disc	69209004B		Pair of spacers L 50 mm 69209094
				Pair of spacers L 130 mm For fitting twin wheels 69209097
				Pair of tyre crampons 10" L0033800
				Pair of snow chains L0021600
	Pair of tyred wheels 5.00x10" Adjustable disc	69209003B		Pair of spacers L 50 mm (required for DIESEL engines) 69209094
				Pair of spacers L 150 mm For fitting twin wheels 69209098
				Pair of snow chains L0030200
	Pair of tyred wheels 5.00x10" Fixed disc	69200023A		Pair of spacers L 150 mm For fitting twin wheels 69209098
				Pair of snow chains L0030200
	Pair of tyred wheels 21-11.00/8" Fixed disc Pair of L 50 mm spacers included (69209094)	69200021A		
Steel wheels				
	Pair of steel wheels Ø 480x100 mm	69209067		Pair of width adjustment rings W 100 mm L0040100

Accessories



Accessory	Optional accessory	
 <p>Oil-immersed drive</p> <p>69229023</p>		<p>0.95 m Complete central cutter plate Semi-fine teeth</p> <p>69229084A</p>
		<p>1.15 m Complete central cutter plate Semi-fine teeth</p> <p>69229085A</p>
		<p>1.27 m Complete central cutter plate Semi-fine teeth</p> <p>69229086A</p>
		<p>1.40 m Complete central cutter plate Semi-fine teeth</p> <p>69229087A</p>
		<p>1.60 m Complete central cutter plate Semi-fine teeth</p> <p>69229093A</p>
		<p>0.95 m Complete central cutter plate Special teeth Side protection discs</p> <p>69229068A</p>
		<p>1.15 m Complete central cutter plate Special teeth Side protection discs</p> <p>69229069A</p>
		<p>1.27 m Complete central cutter plate Special teeth Side protection discs</p> <p>69229070A</p>
		<p>1.40 m Complete central cutter plate Special teeth Side protection discs</p> <p>69229071A</p>
		<p>1.22 m Complete central cutter plate "UNIVERSAL" ESM (requires kit L0058900)</p> <p>69229036</p>
		<p>1.42 m Complete central cutter plate "UNIVERSAL" ESM (requires kit L0058900)</p> <p>69229021</p>
		<p>1.02 m Complete central cutter plate "KOMUNAL" ESM (requires kit L0058900)</p> <p>L0066900</p>
		<p>1.22 m Complete central cutter plate "KOMUNAL" ESM (requires kit L0058900)</p> <p>69229037</p>
		<p>1.42 m Complete central cutter plate "KOMUNAL" ESM (requires kit L0058900)</p> <p>69229038</p>
		<p>Directional guides for semi-fine tooth cutter plate</p> <p>69229098</p>
		<p>Ballast for mechanical drive</p> <p>L0105500</p>
		<p>Ballast for oil-immersed drive</p> <p>L0105700</p>

Accessories



141 M

Accessory		Optional accessory		
Front shovel				
 <p>Front shovel L 100x40 cm Quickfit coupling With horizontal and vertical adjustment</p>	69209065			
Snow thrower				
 <p>Turbine L 60 cm Two stages Adjustable ejector chute Quickfit coupling</p>	L0026200			
Front brush				
 <p>Brush L 100xØ 35 cm With horizontal and vertical adjustment Quickfit coupling</p>	L0094200			
Rotor type flail mower				
 <p>Flail mower L 65 cm 24 "Y" shaped knives Integral safety brake Quickfit coupling (requires QuickFit 69212006)</p>	L0091000			

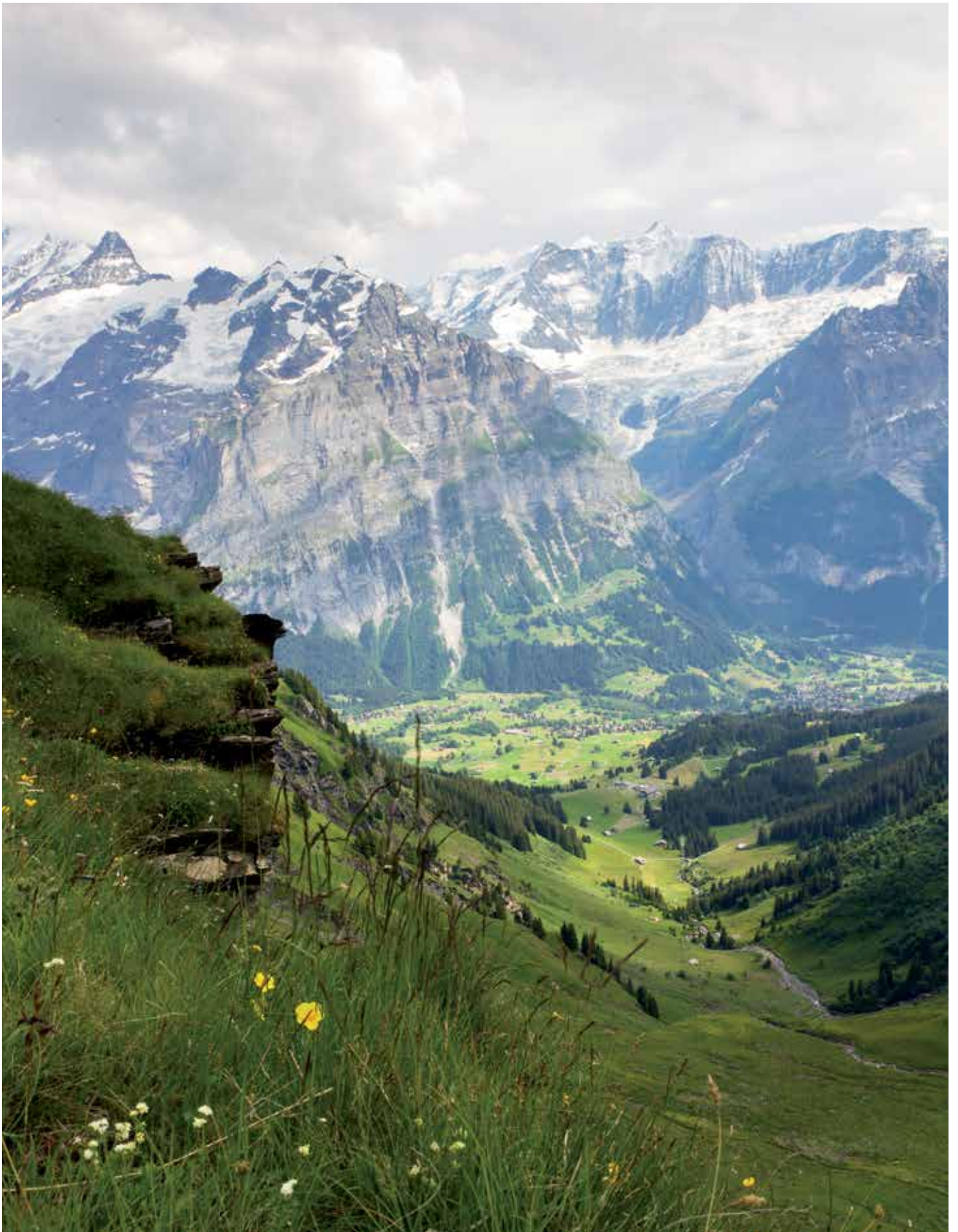

Tough, compact and
easy to handle, for moving
bulky and heavy
loads effortlessly
across all kinds of terrain.



Transporters

HOME



BTR 340



PROFESSIONAL



BTR 450



BTR 550



BTR 550 D



BTR 1750 D



TECHNICAL DATA



gearbox



load capacity



manual dumping



hydraulic dumping



liquid capacity

Transporter for home use

BTR 340



Designed for demanding home users needing to transport all types of material, such as firewood, fruit crates, and other bulky items, this machine is practical and easy to handle on all types of terrain.



Handlebar-mounted gear selection lever.



Speed selection control lever.



Manual dump with automatic locking system.

BTR 340

Power supply	Engine	Model	Displacement	Power	Starting	Code
gasoline	POWERED BY HONDA	GCV 160 OHC	160 cm ³	4.4 HP	recoil start	68719034A
gasoline	Emak	K 650 OHV	159 cm ³	3.7 HP	recoil start	68719030

Focus on accessories



High sides kit
Code **68722010**



Front shovel 85 cm
Code **69209071**



Gearbox/ Speed (km/h):

4-speed (2 forward + 2 reverse)

Speed (km/h)

1.60	1	1R	1.40
3.60	2	2R	3.40

Dimensions (mm)

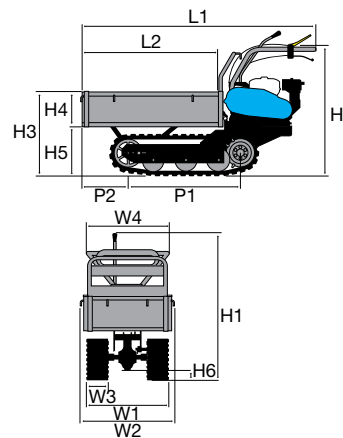

L1	1530-1665
L2	925-1060
H1	965
H2	885
H3	570
H4	240
H5	330
H6	65
W1	590
W2	603-983
W3	170
W4	520-900
P1	690
P2	415-550

Transmission	with oil-bath gearbox
Clutch	belt, with automatic disengagement when the control lever is released
Brakes	with automatic engagement when clutch is released
Load capacity	350 kg
Loading surface	telescoping
Dumping	manual
Dump angle	45°
Steering	with independent control releases and brakes
Minimum steering radius	70 cm
Crawler contact surface	58 cm length – 17 cm width
Power take-off	no
Weight	140 kg

Professional transporter

— BTR 450



Designed to satisfy the needs of professional users, this model stands out for its manageability, strength and high load capacity. It is also fitted with a power take-off for the attachment of accessories.



Belt clutch with automatic disengagement when the control lever is released.



Steering with independently controlled releases and brakes.



Protected, expandable brakes for working in extreme conditions.

— BTR 450

Power supply	Engine	Model	Displacement	Power	Starting	Code
gasoline	POWERED by HONDA	GX 160 OHV	163 cm ³	4.8 HP	recoil start	68729114C

Focus on accessories



High sides kit
Code **68722003**



Front shovel 85 cm
Code **69209071**



Gearbox/ Speed (km/h):

4-speed (3 forward + 1 reverse)

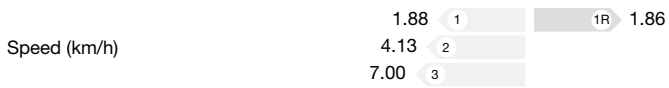

Dimensions (mm)

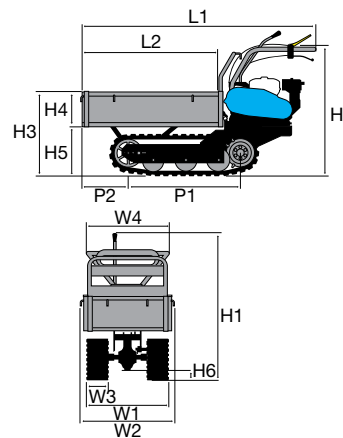

L1	1670
L2	925-1060
H1	1020
H2	900
H3	590
H4	240
H5	339
H6	70
W1	620
W2	643
W3	-
W4	560-940
P1	785
P2	330

Transmission	with oil-bath gearbox
Clutch	belt, with automatic disengagement when the control lever is released
Brakes	with automatic engagement when clutch is released
Load capacity	450 kg
Loading surface	telescoping
Dumping	manual
Dump angle	50°
Steering	with independent control releases and brakes
Minimum steering radius	70 cm
Crawler contact surface	60 cm length - 18 cm width
Power take-off	yes, independent 2100 rpm
Weight	180 kg

Professional transporter

— BTR 550



This is a powerful professional machine, rugged and compact, and idea for use on all types of terrain. With high load capacity, this machine stands out for its versatility and the safety devices installed.



Independent PTO at 2100 rpm.



Steering with independently controlled releases and brakes.



Telescoping loading platform for transporting even the most bulky loads.

— BTR 550

Power supply	Engine	Model	Displacement	Power	Starting	Code
gasoline	POWERED by HONDA	GX 160 OHV	163 cm ³	4.8 HP	recoil start	68729118C

Focus on accessories



High sides kit
Code **68722004**



Front shovel 85 cm
Code **69209071**



Gearbox/ Speed (km/h):

6-speed (4 forward + 2 reverse)

Speed (km/h)	1.88	1	1R	1.86
	3.16	2	2R	3.13
	4.13	3		
	7.00	4		

Dimensions (mm)

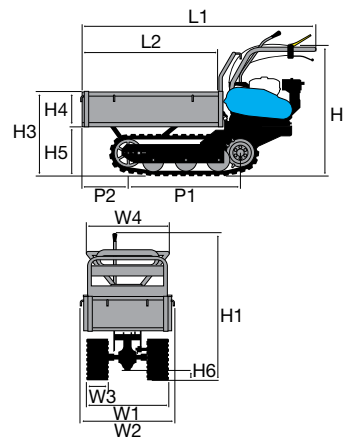

L1	1745
L2	1000-1180
H1	1020
H2	900
H3	590
H4	240
H5	339
H6	70
W1	620
W2	733
W3	-
W4	650-1100
P1	785
P2	405

Transmission	with oil-bath gearbox
Clutch	belt, with automatic disengagement when the control lever is released
Brakes	with automatic engagement when clutch is released
Load capacity	550 kg
Loading surface	telescoping
Dumping	manual
Dump angle	50°
Steering	with independent control releases and brakes
Minimum steering radius	70 cm
Crawler contact surface	60 cm length - 18 cm width
Power take-off	yes, independent 2100 rpm
Weight	200 kg

Professional transporter

— BTR 550 D



Professional model offering a combination of high power, easy handling and high load capacity. The transporter is ideal for applications in the agricultural and building sectors. Tipping is hydraulically operated to provide the maximum possible assistance for the operator during material handling activities.



Lever-operated hydraulic tipping control valve.



Steering with independently controlled releases and brakes.



Protected, expandable brakes for working in extreme conditions.

— BTR 550 D

Power supply	Engine	Model	Displacement	Power	Starting	Code
gasoline	POWERED by HONDA	GX 160 OHV	163 cm ³	4.8 HP	recoil start	68729128

Focus on accessories



High sides kit
Code **68722004**



Front shovel 85 cm
Code **69209071**



Gearbox/ Speed (km/h):

6-speed (4 forward + 2 reverse)

Speed (km/h)

1.88	1	1R	1.86
3.16	2	2R	3.13
4.13	3		
7.00	4		

Dimensions (mm)

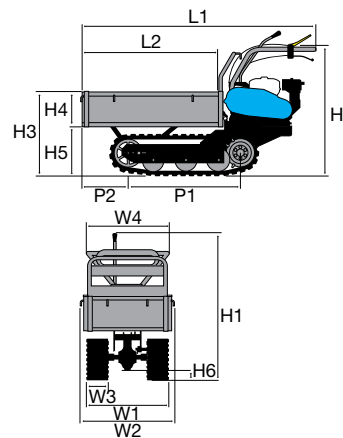

L1	1745
L2	1000-1180
H1	1020
H2	900
H3	590
H4	240
H5	339
H6	70
W1	620
W2	733
W3	-
W4	650-1100
P1	785
P2	405

Transmission	with oil-bath gearbox
Clutch	belt, with automatic disengagement when the control lever is released
Brakes	with automatic engagement when clutch is released
Load capacity	550 kg
Loading surface	telescoping
Dumping	hydraulic
Dump angle	50°
Steering	with independent control releases and brakes
Minimum steering radius	70 cm
Crawler contact surface	60 cm length - 18 cm width
Power take-off	yes, independent 2100 rpm
Weight	215 kg

Professional transporter

BTR 1750 D



Designed for professional use, this is a dumper model machine with hydraulically operated load box tipping: ideal for transporting firewood, stone, sand and other building materials. Its increased dumping angle - 60° - meets the need for creating piles and mounds. Suited to all kinds of terrain, even on slopes, this transporter has a small steering radius, making it easy to handle.



Robust frame suitable for the most demanding jobs.



Dumper loading platform with counter-frame for 60° dump angle.



Crawler tracks made of hard rubber, width 180 mm: assure excellent grip on all types of terrain.

BTR 1750 D

Power supply	Engine	Model	Displacement	Power	Starting	Code
gasoline	POWERED by HONDA	GX 160 OHV	163 cm ³	4.8 HP	recoil start	68729122D

Focus on accessories



Front shovel 85 cm
Code **69209071**



Extendable loading deck
550 kg payload
Code **68722017**



Gearbox/ Speed (km/h):

6-speed (4 forward + 2 reverse)

Speed (km/h)

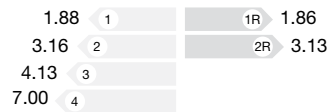

Dimensions (mm)

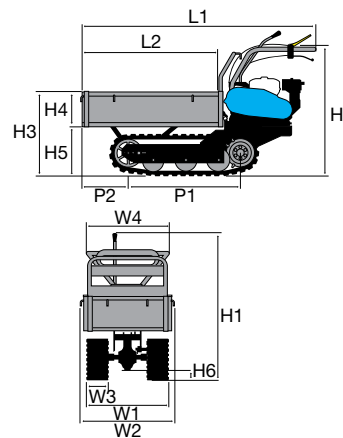

L1	1575
L2	915
H1	1020
H2	900
H3	515-725
H4	405
H5	320
H6	70
W1	622
W2	622
W3	-
W4	620
P1	785
P2	265

Transmission	with oil-bath gearbox
Clutch	belt, with automatic disengagement when the control lever is released
Brakes	with automatic engagement when clutch is released
Load capacity	550 kg - 175 L
Loading surface	fixed
Dumping	hydraulic
Dump angle	60°
Steering	with independent control releases and brakes
Minimum steering radius	70 cm
Crawler contact surface	60 cm length - 18 cm width
Power take-off	yes, independent 2100 rpm
Weight	215 kg

Data and illustrations published in the catalogue are not binding where specifications of materials are concerned, given that these will always be subject to technical improvement. Technical specifications given in the catalogue are subject to change without notice, as also are directions relating to general use of the equipment.

Engine power data refers to the values declared by each manufacturer. These values are calculated in accordance with specific measurement standards (such as SAE J1940, SAE J1349, ISO 1585) and may be modified without prior notice.

Certain items are not available in all countries, or are available only on request.





#100 years



Subject to modifications. Some models are available for certain markets only. - Cod. 3185002I - 2018



It's an **Emak S.p.A.** trademark
42011 Bagnolo in Piano (RE) Italy
www.mybertolini.com

 www.facebook.com/Bertolinitalia
 www.instagram.com/Bertolinitalia